



User manual

Document version:1.0

All rights reserved. Except as expressly provided herein, no part of this manual may be reproduced, copied, transmitted, disseminated, downloaded or stored in any storage medium, for any purpose without the express prior written consent of Flymaster Avionics Lda. herein Flymaster Avionics.

Flymaster Avionics hereby grants permission to download a copy of this manual onto a hard drive or other electronic storage medium to be viewed and to print a copy of this manual or of any revision hereto, provided that such electronic or printed copy of this manual must contain the complete text of this copyright notice and provided further that any unauthorised commercial distribution of this manual or any revision hereto is strictly prohibited.

Information in this document is subject to change without notice. Flymaster Avionics reserves the right to change or improve its products and to make changes in the content without obligation to notify any person or organisation of such changes or improvements. Visit the Flymaster Avionics website (www.flymaster-avionics.com) for current updates and supplemental information concerning the use and operation of this and other Flymaster Avionics products.

Warning It is the sole responsibility of the pilot to operate the aircraft in a safe manner, maintain full surveillance of all flying conditions at all times, and not become distracted by the Flymaster NAV SD . Flymaster Avionics is not responsible for any damages resulting from incorrect or no data provided by the Flymaster NAV SD . Flight safety is the sole responsibility of the pilot.

It is unsafe to operate the Flymaster NAV SD while in the air. Failure by the pilot equipped with a Flymaster NAV SD to pay full attention to the aircraft and flying conditions while flying could result in accident with property damage and/or personal injury.

Contents

	Page
1 Getting Started	4
1.1 Charging the Battery	4
1.2 NAV SD Keys	4
1.3 Using keys Inside Menu	5
1.4 Switching NAV SD On and Off	5
1.5 Resetting the NAV SD	6
1.6 Setting the Volume	6
1.7 Flight Start and Recording	6
2 Flight Mode	7
3 NAV SD Elements	8
3.1 Graphical Elements	8
3.1.1 Battery	8
3.1.2 Sound	8
3.1.3 <i>GPS</i>	9
3.1.4 Vario	9
3.1.5 Navigation Circle	11
3.1.6 Airspaces Map	13
3.1.7 Altitude graph	14
3.1.8 Wind Arrow	15
3.1.9 Map Page	15
3.2 Data field Elements	17
4 Menu mode	21
4.1 Waypoints and Task	22
4.1.1 Waypoints Actions Menu	23
4.1.2 TaskList	24
4.2 Task Delay	27
4.3 TaskNavigator	28
4.4 Critical Airspaces	28
4.5 Nearby Landings	29
4.6 Flight Log	30
4.7 Pages	32
4.8 Settings Menu	34
4.8.1 Set Altimeter	34
4.8.2 Time	35
4.8.3 Vario Acoustics	35

4.8.4	Alerts	37
4.8.5	Advanced Features	38
4.8.6	Trace	39
4.8.7	Screen	41
4.8.8	Language/Units	43
4.8.9	Device Settings	43
4.8.10	RF Probes	43
4.8.11	Probe Alerts	44
4.8.12	Polar	45
4.8.13	Data fields	46
4.8.14	FS Keys	46
4.8.15	Navigation Settings	47
4.8.16	Airspace settings	47
4.8.17	GPS status	48
5	TaskDefinition	50
5.1	Setting up the task	50
6	McCready Functions	53
7	Firmware	54
8	Interfacing with GPSDump	56
8.1	Configuring GPSDump	56
8.2	Uploading Waypoints	57
8.3	Downloading tracklogs	59

1 Getting Started

Fully charge battery before using your Flymaster for the first time.



Figure 1.1: right view

The battery may be charged by either connecting the NAV SD USB connector to the wall socket charger, or to a powered USB port using the USB cable. USB connector can be found on the right side of the NAV SD (see figure 1.1).

1.1 Charging the Battery

Flymaster NAV SD has an advanced battery power management system, which gives the pilot accurate information about the battery state, as well as the charging time and battery remaining time.

To charge the Flymaster NAV SD battery you may use the wall charger, the USB cable, or the car charger. Original Flymaster accessories are recommended in order to avoid damage to the power management system.

The Flymaster NAV SD has 2 charging modes, namely, *Quick Charge* and *Slow charge*. The charging mode choice is automatic and based on the power source. *Quick charge* mode is activated when charging with the wall charger or the car charger, while *Slow Charge* mode is activated when a USB cable connected to a PC or MAC is used.

Charging, and battery status information is shown on both the power up screen and the *Shutdown* menu. When the Flymaster NAV SD is connected to a power supply (wall charger or via USB cable), even with the unit off, the instrument will show if it is being *Slow* or *Fast* charged. The time remaining to full charge is also shown. This may not appear immediately when a power source is connected, since the instrument requires some time to calculate the remaining charge time. A *Slow* charge is ok for topping up the battery but not for fully charging. Use the wall or car charger to fully charge the instrument.

Note: The instrument will not charge when it is turned on and connected to a PC. The instrument must be turned off in order to charge the battery using the PC USB port. This behavior is deliberate to prevent overwhelming competition organizer's download hubs.

Note: Charging the instrument with high ambient temperatures should be avoided. Such action can cause the battery to overheat and affect battery health.

1.2 NAV SD Keys

Four keys are used to interact with NAV SD (see Figure 1.2). In this manual we will call MENU key - S1, ENTER key - S2, UP key - S3, and DOWN - S4. Each key has 2 functions depending whether the device is in flight mode or in menu mode. Additionally the MENU key is used to *power-up* the NAV SD when it is switched off.



Figure 1.2: NAV SD keypad

In the flight mode Keys S2, S3 and S4 have user configurable functions F1, F2 and F3. Functions are allocated in the Menu->Settings->FS Keys (see Section 4.8.14).

Note: If the active page includes a Map (Task Map, or Airspaces Map) FS Keys definition will be ignored. In this case S3, and S4, will zoom in and out of the map whilst the S2 will switch page.

In menu mode all keys have fixed functions shown by symbols on the keys namely S3=Move Up S4=Move Down, S2=Enter and S1=Back(Exit).

1.3 Using keys Inside Menu

Changing parameters on the NAV SD can be performed through the menu. Changing a parameter involves accessing the menu, selecting an option, and then changing a specific field value. Accessing the main menu can be done by pressing the MENU key in flight mode. Once in the menu, UP(S3), and DOWN(S4) keys can be used to scroll up and down through the menu options list. During the scrolling process the selected option is highlighted. The ENTER(S2) key should be used to access the option. Depending on the menu option, a new menu options list, or a data fields list appears. In any time pressing the MENU(S1) key takes you back. When accessing data fields the associated menu option becomes *grayed* and the respective field data item is highlighted. Using the UP and DOWN keys changes the value on each field. Pushing the ENTER key moves to the next field, or in some cases to the next character/digit. Conversely, pushing MENU key moves to the previous field, or to the previous character/digit. If the ENTER key is pushed on the last field all the data in the selection section is stored and control returns to the configuration menu. Inversely, if the MENU key is pushed on the first data field the changed settings are ignored and control is returned to the configuration menu.

Tip: When setting a data field that involves setting several characters, e.g. when defining a waypoint name, after defining the desired characters, pushing the ENTER key continually for more than 2 seconds will make the cursor jump to the next data field, or return to the configuration menu if no more data field needs to be set.

1.4 Switching NAV SD On and Off

To switch on the NAV SD, briefly push the S1 key (Menu Key). This will display the start up screen with a 10 second countdown. Pushing the S2 (Enter key) before the 10 seconds have elapsed will power up the NAV SD. The NAV SD initiates in flight mode. If the S2 key is not pushed within 10 seconds the NAV SD returns to sleep. To switch off the NAV SD, push the S1(menu key) to activate menu mode, then use the S3 or S4 to select the *Shutdown* item, and finally push the S2 Key.

1.5 Resetting the NAV SD

The reset procedure allows the pilot to restart the NAV SD in the unlikely event that it freezes, or stops responding (if this ever occur please report it to our support email). To reset the NAV SD push S1 (Menu) key and the S4 (Down arrow) key, simultaneously, for at least two seconds. The display will go blank and after will return in Flight mode.

Note: Resetting the NAV SD will also reset flight data, e.g. task status.

1.6 Setting the Volume

The NAV SD sound volume can be adjust using one FS Key, or trough the *Vario Acoustics* option of the *Settings* Menu (see Section 4.8.3). The NAV SD has six different sound levels, plus *no sound*. The current volume level can be seen using the sound element (see Section 3.1.2 for more details).

Pressing the defined FS Key will scroll up the sound level until the maximum value. Pressing more will mute the sound before start scrolling again starting from the minimum value.

Note: Changing the volume using an FS key is only valid for the current flight, and will not override the volume level setting. Every time the instrument is turned on, if the sound is muted, an alarm is generated in order to notify the pilot.

Note: When the instrument is turned on the sound can be muted despite the volume level settings. This occurs due to the *Auto silent* mode is activated (see Section 4.8.5 for more details)

1.7 Flight Start and Recording

Most of the NAV SD features are only available after the *Flight Start*. This procedure is taken in order to avoid wrong calculations due to missing data. Flight starts when all of there 3 conditions are met:

1. GPS 3d fix is established;
2. Speed goes over the configured *Start Speed* (default value is 8km/h)
3. Average vario is greater than $\pm 0.15\text{m/s}$

2 Flight Mode

The Flymaster NAV SD has two main working modes, namely Flight mode, and Menu mode. Flight mode is used during flight, and this allows the user to see information such as Altitude, Speed, or Vario. The NAV SD can have up to 16 different pages (see Figure 2.1) in memory. Each page corresponds to a different screen, which can be completely configured by the user. A set of 16 pages is called a Layout. Once a Layout containing multiple pages has been defined, the user can configure one function key to switch page (see Section 4.8.14 for some page examples) in *Flight Mode*. Pages can also be switched automatically using triggers (see Section 4.8.7).

Note: If the active page includes a Map (Task Map, or Airspaces Map) S2 key will switch page.

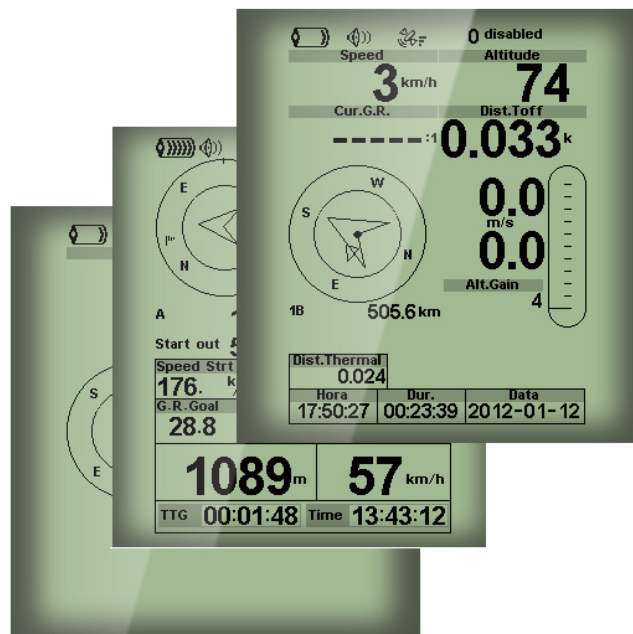

Figure 2.1: Page examples

Screen layout can be configured by the user using a free application, called *Flymaster Designer* which can be downloaded from the Flymaster website (www.flymaster.net). This intuitive tool allows the user to create an unlimited number of layouts, which can be saved to the computer, uploaded to the instrument, and even shared with other Flymaster users. See the Designer user manual, available on the website for more information about the Designer tool.

Designing a Layout consists of inserting a set of objects, called *Elements*, in the desired position, and with the desired dimensions, in each of the available 16 pages. The Designer works by *what you see is what you get*. This means that when you insert a element in a page, and after uploading the layout to the instrument, you will see exactly the same thing on the NAV SD screen.

Note: If a Layout is uploaded to the NAV SD the previews layout is deleted (all pages are deleted).

There are several elements available for the NAV SD which are presented in the following section.

3 NAV SD Elements

The main objective of an element is to provide information to the user. Elements can be Graphical, or Data Field type. Each element has its own properties which can be changed in order to alter the element behaviour, and/or shape.

3.1 Graphical Elements







Graphical elements are characterized by providing information in a graphical way. Most of the graphical elements have fixed dimensions, although their position can be altered.

As the NAV SD firmware evolves the list of Graphical Elements will likely grow. The current list includes the following graphical elements.

3.1.1 Battery

The Battery Element provides a graphical indication of the current battery level. In Table 3.1 it is possible to see the relationship between what is shown and the actual battery level in percentage. This element has fixed dimensions.







Table 3.1: Battery Element description

Symbol	Description
	Battery level above 90%
	Battery level between 70% and 89%
	Battery level between 50% and 69%
	Battery level between 30% and 49%
	Battery level between 15% and 29%
	Less than 15% battery remaining

3.1.2 Sound

The Sound Element provides graphical representation on the current volume level. Table 3.2 Shows the relationship between what is shown and the sound level. This element has fixed dimensions.

Table 3.2: Sound Element description

Symbol	Description
	Sound Level 6 (maximum sound level)
	Sound Level 5
	Sound Level 4
	Sound Level 3
	Sound Level 2
	Sound Level 1
	Sound is muted (No sound)

3.1.3 GPS

The *GPS* Element provides graphical indication about the current *GPS* signal quality. Basically, the lower the PDOP value (position dilution of precision), the more accurate calculations are for determining position. Values bellow 3.0 are fairly accurate. The relationship between what is shown and the signal quality can be seen in Table 3.3. Note that FAI rules require 3D tracklog data, which includes *GPS altitude*.

Table 3.3: GPS signal quality

Symbol	Description
📶	3D position with a PDOP bellow 1.5
📶	3D position with a PDOP between than 1.5 and 2.0
📶	3D position with a PDOP between than 2.0 and 3.0
📶	3D position with a PDOP greater than 3.0
📶	2D position (no altitude information)
📶	No GPS Signal

Therefore the NAV SD will only start recording a tracklog when 3D information is available. The NAV SD has an high sensitivity 50 channel GPS receiver which offers unmatched tracking performance in harsh signal environments (-160 dBm sensitivity), and very short acquisition times. The NAV SD has a 4 Hz GPS update rate (most of others only provide 1Hz) which allows the NAV SD pilot to see very small speed and position changes. Furthermore, the movement of the direction arrow is smoother and any position change is shown in a quarter of the time of other devices. Note that the 4 Hz update rate requires more than 5 satellites in view. More information about *GPS* accuracy and also other *GPS* related information can be seen in (http://en.wikipedia.org/wiki/Error_analysis_for_the_Global_Positioning_System).

3.1.4 Vario

The Analog Vario Elements shows information regarding the analogue instantaneous vertical speed. There are four different Elements that can be used to display the vario. All of these element can be resized and re-positioned.

Analog Vario

This Element which can be resized and repositioned, graphically represents the rate of climb, scaled from 0 m/s to +/-10 m/s depending if you are climbing or sinking Figure 3.1.



Figure 3.1: Analog Vario

When the NAV SD detects that the pilot is climbing, a black bar starts to grow on the left, from the bottom of the scale to the top, with 0.1 m/s increments. The same bar grows on the right, from the top of the scale to the bottom, if sinking is detected.

Big Analog Vario

The *Big Analog Vario* element shows the instantaneous vertical speed (Figure 3.2). This element can be resized and re-positioned.



Figure 3.2: Big Analog Vario

This Element graphically represents the rate of climb, scaled from 0 m/s to +/-10 m/s depending if you are climbing or sinking. In this Element a black bar starts from the middle of the scale and grows at 0.1 m/s increments, up to 5 m/s at the top of the scale. When 5 m/s value is reached the black bar starts to disappear from 0 m/s (middle of the scale) until the top of the scale. When the bar completely disappears the climbing rate is equal, or above 10 m/s. The same process occurs when descending, but from the middle of the scale to the bottom.

Double Bar Analog Vario and McCready Indicator

The Double Bar Analog Vario element shows not only the instantaneous vertical speed, but also the *Average Thermal* and *Next Expected Thermal* (McCready Indicator) (see Figure 3.3). This element can be resized and re-positioned. The element consists of 4 columns. In the left most column a black bar is shown which indicates the average thermal climb rate. This value is always positive. In the next column a double arrow is shown which indicates the next expected thermal climb rate. Finally, the last columns show 2 bars indicating the climb rate and the sink rate. See more about the McCready indicator in Chapter 6.

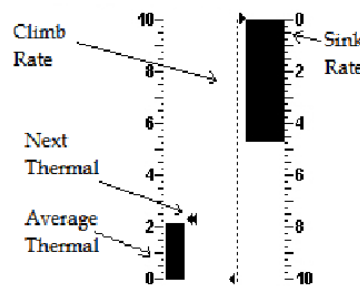

Figure 3.3: Double Bar Vario and McCready Indicator

Dial Analog Vario

The Dial Analogue Vario element shows the instantaneous vertical speed (Figure 3.4). This element can be resized and re-positioned. Climb or sink rates are shown by the position of the needle on the analogue dial. The maximum and minimum climb rates can be set using the DESIGNER software.



Figure 3.4: Dial Vario

3.1.5 Navigation Circle

The Navigation Element is a multi-information element which shows graphically the bearing, wind direction and thermal core. Additionally, if a destination was defined (waypoint) the navigation element will also indicate the direction to the waypoint center, the waypoint edge and the direction to the waypoint after the next one. This element cannot be resized but can be re-positioned. For navigation information to be displayed the NAV SD the *Start Flight* conditions must be met (see Section 4.8.5).

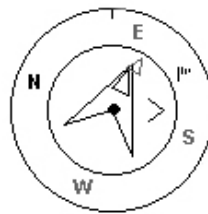

Figure 3.5: Navigation Element

Navigation information is shown within the inner most circles. The external circle contains the cardinal points and the Wind Flag. The current traveling direction (bearing) corresponds to the point indicated in the top of the navigation circle. On the example shown in Figure 3.5, the bearing is approximately 80°.

Navigation Arrows

When a route is active the *direction of next optimal point* is pointed by an arrow (larger arrow 1). The *optimal point* corresponds to the unique point on the waypoint cylinder which lies along the optimal route (red route in the Figure 3.6 example). If no route is defined the arrow will start showing the direction to the takeoff, after the takeoff is detected (TakeOff is the point taken when the Flight Starts)

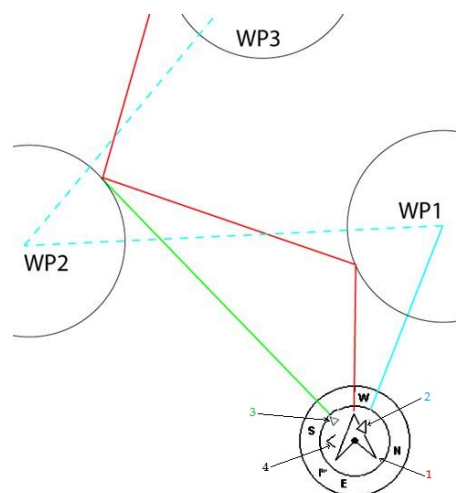

Figure 3.6: Route Optimisation

During a competition task flight using the optimal tangent navigation saves a substantial amount of time.

The smaller arrow 2 in the Figure 3.6 example points to the centre of next waypoint cylinder (WP1), and the arrow 3 points to the optimised edge of the waypoint after the next one (WP2). The combination of all three arrows provides a spatial location of the pilot relative to the next 2 waypoints. The example in Figure 3.6 shows a hypothetical task. A pilot navigating to the centre of the waypoint (following arrow 2) will probably be flying the blue course, whilst a pilot navigating using arrow 1, so probably flying the optimised route (red course), will fly the substantially shorter route. The direction to the waypoint after the next one (WP2) is represented by arrow 3. In the example arrow 3 is pointing along the green line, which shows the direction to WP2, even though WP1 has not been reached. Small course corrections are sometimes required and these are shown on the NAV SD by a *fine adjustment indicator* in the form of the small arrow 4. Arrow 4 to the left means the pilot should turn slightly to the left, and inversely arrow 4 to the right indicates a small adjustment to the right is needed. In the example of Figure 3.6 arrow 4 is pointing to right indicating that the pilot should turn right slightly.

When the course is perfect, i.e. less than 1° off, the NAV SD indicates this by showing a large arrow forward (Figure 3.7).

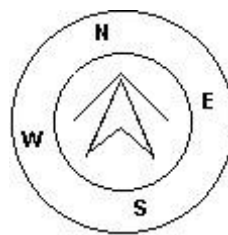

Figure 3.7: Perfect Heading

Note that, a start is automatically validated when a pilot correctly completes the start. Until the start is valid the NAV SD will not advance to the next point in the route. Another important aspect of the start is that the NAV SD does not point to the start cylinder but rather to the next turn point on the list. The distance to the start will become highlighted when the pilot is in an irregular position, i.e. inside a start cylinder where he should be out or vice-versa.

Thermal Core Map

Another useful feature of the Navigation Circle Element is the thermal core map. This map corresponds to a black dot which is shown inside the inner navigation wheel (together with the navigation arrows). During a thermal climb the NAV SD keeps track of the strongest climb values point for each 50m layer. The point of strongest lift is then graphically represented by the black ball in the inner Navigation Circle, showing where the thermal core is relative to the pilot's position. The position of the dot (thermal core) is constantly updated as the pilot moves. When the pilot is over 300m from the thermal core the dot will be at the edge of the circle. As the pilot moves closer to the thermal core the dot will move towards the center.

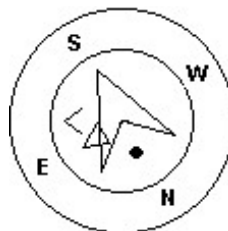

Figure 3.8: Thermap Core Map

In Figure 3.8 the thermal core is currently behind the pilot at a distance of approximately 150 meters (half of 300 m wheel radius).

Wind Flag

The external circle contains a small flag which indicates the Wind Direction relative to the pilot direction (*direction the wind is coming from*). For example, if the pilot is facing the wind then the flag is on the top of the circle. In the example of (Figure 3.5) the wind is blowing from Northeast.

3.1.6 Airspaces Map

The *Airspaces Map* element provides information to the user relative to specific three-dimensional objects, previously loaded to the instrument. Each of these objects can be an airspace volume. Airspace information can be loaded to the instrument using the Flymaster Designer software (see Designer user manual for more information). The NAV SD only accepts data in the *OpenAir* format, and it has a limitation of 12000 polygons points. (See http://www.gdal.org/ogr/drv_openair.html for more information about the open air format).



Figure 3.9: Airspace Element

When the element of Figure 3.9 is inserted in a layout using DESIGNER, a 2D map (box) is shown on the instrument (see Figure 3.10). On the bottom left of the map the scale is indicated in Km, and on the centre of the map is an arrow. This arrow represents the pilot position, and its orientation indicates the bearing of the movement. The map is always oriented *North Up*.

Note: When new Airspaces data is uploaded to the NAV SD using DESIGNER the previous data is deleted. If an empty Airspaces data file is uploaded then all the Airspaces will be deleted.

The first time the map is drawn, it is centred on the last GPS position the NAV SD has in its memory. The map is re-centred once the flight starts i.e. when a valid gps signal exists, and the *start speed* (see Section 4.8.5) is reached.

Note: After new Airspace data is uploaded to the NAV SD it can only be seen on the Map after the *Flight Starts*.

Once the flight starts, the map is redrawn with an arrow (representing the pilot) which will move around the map, indicating the relative position of the pilot to each of the airspace areas. If the pilot is outside a visible airspace area then a gray line is used to draw the area, whereas if the pilot is inside the airspace then a black line is used instead. Note that being inside a airspace area (2D) does not mean that the airspace is being violated, since the pilot can be above, or below the defined 3D shape. In order to have more information about possible airspace's violation, some data fields should be added to the layout. These data fields are Distance to CTR, Altitude to CTR, and CTR Status (Figure 3.10).

The *Dist. CTR* data field shows the shortest horizontal distance to the nearest airspace line. This distance is always positive. Similarly, the *Alt. To CTR* shows the shortest vertical distance to nearest airspace line. Unlike the horizontal distance, the vertical distance can be negative. A positive vertical distance indicates that you are outside the airspace, whereas a negative distance indicates that you are inside the airspace. Additionally, the *CTR status* field will indicate if an airspace is being violated by displaying *Violating*. If the pilot is not violating the airspace but it is inside a predefined margin then the messages *Altitude Imminent*, or *Position Imminent* will be shown.

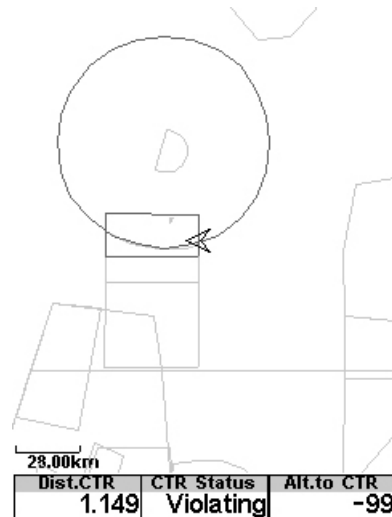

Figure 3.10: Airspace Map and Associated Data Fields

When the page contains an airspace map element, the UP, and DOWN keys, can be used to change the map scale: pressing the UP key will decrease the scale, and the DOWN key will increase the scale. The corresponding *user defined key function* will be disabled.

3.1.7 Altitude graph

The Altitude graph element (Figure 3.11) corresponds to a graph of barometric altitude versus time. Altitude is shown in the vertical axis graduated in meters with time shown on the horizontal axis graduated in seconds.

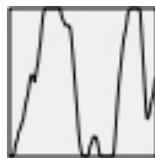

Figure 3.11: Altitude Graph Element

The range of the horizontal axis is fixed and corresponds to 240 seconds (4 minutes), while the range of the vertical axis is automatically adjusted in order to accommodate the gained height. In reality the altitude graph element is a plot of the absolute barometric altitude over the last 4 minutes of flight (Figure 3.12).

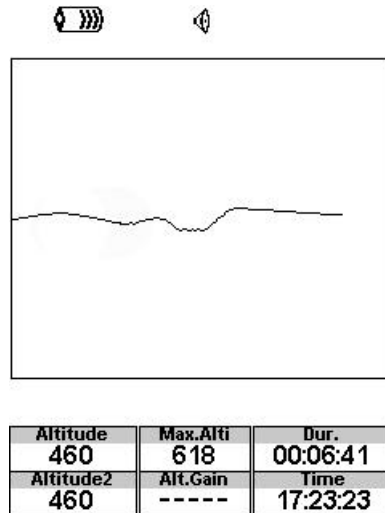

Figure 3.12: Altitude Plot

3.1.8 Wind Arrow

The *Wind Arrow* element (Figure 3.13) is a re-sizable graphical element.

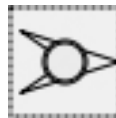

Figure 3.13: Wind Arrow Element

When used in a layout an arrow is draw showing the wind direction relative to the pilot direction (*direction the wind is coming from*). For example, if the pilot is facing the wind then the arrow points south (bottom of the screen). Centered over the arrow is a circle in which a number is displayed showing the wind speed in Km/h (Figure 3.14). In the example of (Figure 3.14) the wind is blowing from East. Both, the wind speed, and direction, value can be seen in a data fields.

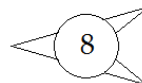

Figure 3.14: Wind Arrow

Note that both wind direction, and speed, are calculated based on the GPS ground speed while the pilot is turning, so there is no need of wind speed probe. The wind speed calculation accuracy increases with the number of turns made.

3.1.9 Map Page

The MAP element (Figure 3.15) provides information to the user about their position relative to waypoints, cylinder edges and the pilot's trace or track. This element can be resized and moved around the screen.



Figure 3.15: Map Element

A typical map page in flight may look like Figure. 20. In this figure is shown the scale on the bottom left. The scale can be manually changed by pressing the F1 button to enlarge the map and therefore reduce the scale, and conversely by pressing the F2 button to reduce the map and therefore increase the scale.

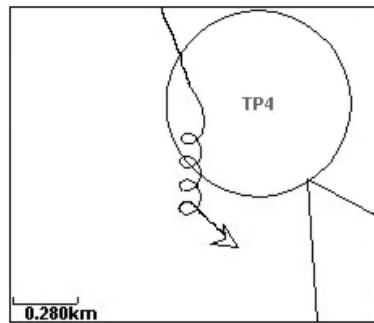

Figure 3.16: Map Page

If flying a competition route, the optimized route is drawn between the turnpoint cylinders. The position of the pilot is indicated by the arrow and the trace for the last approximately 4 mins of the flight is shown. Traces older than 4 mins are erased to reduce clutter on the screen.

3.2 Data field Elements

Data field elements can be used to shown numerical information like altitude, vertical speed, speed, glide ratio, and many others.

These elements have configurable size, and position, although the text within has only 3 possible sizes. The following table explains the available data fields. As the NAV SD firmware evolves this list will likely grow.

Table 3.4: Data fields Description

Field ID	Description
A.OverGoal	Altitude over goal is the difference between the current altitude and the goal's altitude based on barometric pressure values.
Above Toff	Altitude above takeoff is the altitude over the flight starting point.
Abs.Pressure	Absolute atmospheric pressure value in Pascals.
Active waypoint	Active turnpoint name.
AirTemp.	Air Temperature as measured by the wireless speed probe.
Alt.Gain	Altitude Gain. Altitude gained in current thermal.
Alt.Gain/Loss	Altitude Gain/Loss. When at the top of the thermal displays the altitude gained from the base of the thermal, else displays the altitude lost since reaching the top of thermal.
Alt.to CTR	Altitude to CTR shows altitude to controller airspace, a negative number indicates we must sink to come out of controlled airspace.
Altitude	Current altitude. This altitude is calculated based on the barometric pressure and depends on the QNH value.
Altitude2	Second Altimeter which can be set independently to the main altimeter.
Arrival Goal	Estimated arrival height above Goal. The height is calculated considering the average glide ratio that has being made. This means that wind, day quality and glider performance are used in the calculations.
Arrival Next	Estimated arrival height above the next waypoint. This means that wind, day quality and glider performance are used in the calculations.
Ave.Speed	Average ground speed calculated using a filter to show a smoothed speed, eliminating erratic speed changes due to glider pitching, etc.
Ave.Vario	Average Vario calculated using an integration time constant in order to indicate smoother climbing rates.
AveROT	Average rate of turn in degrees per second.
Battery	Shows battery strength as a percentage of complete charge
Bearing	Current bearing in degrees.
Ceiling	Shows the upper altitude of the airspace causing the warning, i.e. airspace that you are violating or close to violating.
ConeVSpd	The minimum thermal speed which compensates stop to climb instead of going straight to the Conical End of Speed Section.
CTR Name	Name of the airspace causing warning or violation.
CTR Status	Status message of airspace, will show <i>Violating</i> when in controlled airspace, <i>Imminent Alt</i> when close to entering airspace vertically or <i>Pos.Imminent</i> when close to entering airspace horizontally.
Cur.G.R.	Current glide ratio calculated using the average vario value, and average ground speed.
Date	Current date. This value is automatic set when the device gets a valid GPS Signal

Continued on next page

Table 3.4– continued from previous page

Field ID	Description
Dist.CTR	Distance to controlled airspace. When more than one airspace area is in range the closest will be shown. When inside an airspace area the distance shown is to the closest edge.
Dist.Cone	Horizontal distance from the pilot position to the cone.
Dist.ConeA	Horizontal distance from the pilot to the cone arrival point.
Dist.Edge	Distance to Edge. Shortest distance to the optimal point of the next waypoint using route optimisation.
Dist.Goal	Distance to goal is the total distance from the current position to the goal. The distance is calculated considering that the optimal route is made through all pending turnpoints.
Dist.Line	Distance to Line. Shortest distance to the waypoint line circle. Distance line corresponds to the Distance Next minus the waypoint radius.
Dist.Next	Distance to Next. Shortest distance to the waypoint center. Distance next corresponds to the Distance Line plus the waypoint radius.
Dist.Start	Distance to start. Shortest distance to the start cylinder.
Dist.Thermal	Shortest distance to last thermal core (thermal dot).
Dist.Toff	Distance to take off is the distance between the current point and the flight starting point.
Dur.	Flight Duration. Duration of the current flight.
Flight Level	Current altitude in hundreds of feet, based on a fixed QNH of 1013.25hPa.
Floor	Shows the lower altitude of the airspace causing the warning, i.e. airspace that you are violating or close to violating.
Fuel	Fuel level in liters (available when connected with Flymaster M1).
G-Force	Current G-Force being experienced by the pilot when using the Heart-G sensor.
Goal Close	Remaining time to goal close.
GPS Alti	Altitude reported by the GPS.
G.R.Goal	Glide ratio to goal. Necessary glide ratio to reach the Goal considering that the optimal route through remaining waypoints is made.
G.R.M.G.	Glide ratio made good. The actual glide ratio towards the active turn point. It is calculated using the integrated vario, and the VMG.
G.R.Next	Glide Ratio to Next. Necessary glide ratio to reach the next turn point.
G.R.Toff	Glide ratio to takeoff. Necessary glide ratio to reach the take off.
Heading	Heading in degrees returned by GPS.
Int.Temperature	Temperature inside the instrument.
Land In	During competition tasks it is common, usually due to safety reasons, to have a <i>land by</i> time. The land by time is defined by adding a waypoint typically the goal to the already defined task, setting it as <i>Landing</i> and defining the time. <i>Land in</i> shows the amount of time remaining before having to be on the ground.
Latitude	Current position latitude according to the format defined in the settings menu.
Longitude	Current position longitude according to the format defined in the settings menu.
Max.Alti	Maximum altitude reached during current flight. This is based on barometric altitude.

Continued on next page

Table 3.4– continued from previous page

Field ID	Description
Max.Climb	Once a flight has started, it shows the maximum rate of climb encountered during the flight. This value uses the integrated vario not the instantaneous rate of climb. This provides good indication of the quality of the day's thermals. This value is reset when the instrument is switched off.
Max.Sink	Once a flight has started shows the maximum sink encountered during the flight. Note that these values are using the integrated vario. When the instrument is switched off this value is reset back to zero.
Max.Speed	Maximum Speed (returned by GPS) reached during the flight. When the instrument is switched off this value is reset back to zero.
McRdyNxtThrm	Next thermal expected average speed calculated based on the McCreech Theory. Considering the defined polar it calculates the speed next thermal should have if you are flying at a certain measured True Air Speed (TAS Probe needed). This value is related with the Speed to Fly and is shown graphically in the Double Bar Vario.
MotorTemp	Motor Temperature (available when connected with Flymaster M1).
OptGndSpdCone	The Ground Speed that you should fly in order to minimize the time to reach the Conical End of Speed Section. This value is calculated adding the Wind over the current course to the Optimal Speed To Cone.
OptSpdCone	The True Air Speed that you should fly in order to minimize the time to reach the Conical End of Speed Section. This value is calculated based on the Cone ratio and the defined polar.
Page Num.	Current layout active page number.
Pulse	Current heartbeat in beats per minute, when using the Flymaster Heart-G sensor.
RPM	Motor revolutions per minute (available when connected with Flymaster M1).
Speed	Indicates ground speed. The speed is only available when the GPS receiver has a valid signal.
Speed Strt	Speed to Start. The speed at which the pilot must fly in order to reach the start gate exactly at its opening.
SpeedToFly	Optimal Speed to Fly value calculated according the McCreech Theory. The True Air Speed value is calculated based on the defined polar and the average thermal speed.
TAS	True Air Speed. This information is available when the instrument is used in conjunction with the Flymaster TAS pitot probe.
Therm.Dur.	Time pilot has spent in the most recent thermal.
Thermal top	The highest point reached during the current thermal.
Thrml.Perfo.	Performance of the most recent thermal showing average rate of climb in most recent thermal.
Time	Current local Time. This value is automatic revised when the device gets a valid Gps Signal. (see Note 2)
Trans.G.R.	Glide ratio during transition. Average glide ratio during transitions between thermals.
Continued on next page	

Table 3.4– continued from previous page

Field ID	Description
TTG	The TTG field is dynamic and will vary according to the current flight status and type of task defined. It will show TTG (time to go) before start gate opening, and will then change to SS (Speed Section time) which is the time elapsed after the opening of the start. If no start gates are defined in the task, or no task is defined, then this field will show Dur, which in this case is the time elapsed since takeoff. The takeoff event is triggered when ground speed exceeds 5km/h and a 3D fix is available.
Turnpoint size	Radius of the active turnpoint.
Steps	Number of steps taken since counting initiated.
Steps/Min	Cadence showing number of steps per minute.
Vario	Instant vario value.
VMG	Velocity made good, is the speed at which the pilot is approaching the active turn point.
Voltage	Current battery level in Volts.
Wind Dir.	Wind direction in degrees, calculated from gps when drifting.
Wind Speed	Calculated wind speed using gps speed.
UDF 1	User defined field 1. The data shown can be user defined.
UDF 2	User defined field 2. The data shown can be user defined.
UDF 3	User defined field 3. The data shown can be user defined.
UDF 4	User defined field 4. The data shown can be user defined.
UDF 5	User defined field 5. The data shown can be user defined.
UDF 6	User defined field 6. The data shown can be user defined.

Note- The NAV SD considers a thermal has been entered when the integrated vario value is above 0.5m/s and considers the thermal as been exited when the integrated vario goes bellow -1.0 m/s. Once in the thermal the Gain indicator will keep track of the maximum altitude reached in the thermal. If the altitude is less than the the max thermal altitude then a negative number will show the difference from the highest point reached. If the altitude is equal or higher than the maximum reached then a positive number will show the altitude gained since entering the thermal. The Gain indicator keeps track of how much altitude is being gained in the thermal. When a pilot enters a thermal the NAV SD will reset the Gain indicator to 0 and will start to track how much altitude the pilot has gained. At a certain point in the thermal the lift may become weaker and inconsistent. At this point the gain indicator will show altitude loss in this inconsistency. Once the pilot climbs in the thermal again the indicator will show the gain since entering the thermal.

Note- All the internal NAV SD time calculations are based on UTC (Coordinated Universal Time). This is also the time saved on the track-log. However, the time displayed in the time field is calculated adding an UTC offset to the UTC time obtained from the GPS receiver. The UTC offset should be defined in the settings menu (see Section 4.8.2) so that the correct local time is displayed.

Note- The TTG field is dynamic and will vary according to the current flight status and type of task defined. It will show TTG (time to go) before start gate opening, and will then change to SS (Speed Section time) which is the time elapsed after the opening of the start. If no start gates are defined in the task, or no task is defined, then this field will show Dur, which in this case is the time elapsed since takeoff. The takeoff event is triggered when ground speed exceeds 5km/h and a 3D fix is available.

Note- The Altitude field indicates the absolute height in meters or feet depending on the setting. This altitude corresponds to the barometric altitude and thus depends totally on the QNH (absolute pressure at a given moment and location in regards to the correspondent pressure at MSL). The altimeter cannot be reset, but can be set using the corresponding menu option (see Section 4.8.1).

4 Menu mode

When in flight mode, pushing the menu (S1) button accesses the menu mode. When in menu mode pushing the menu(S1) button will go back to flight mode.

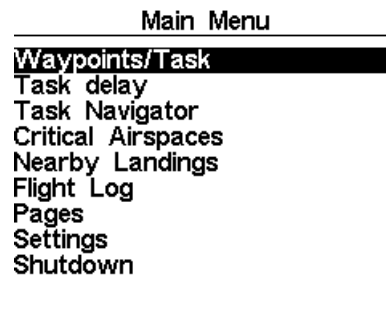

Figure 4.1: Main Menu

To access the different items on the menu you can use the UP(S3) and DOWN(S4) keys. Once a menu item is selected pushing the ENTER (S2) executes the selected function. A short description of each option can be seen in Table 4.1.

Table 4.1: Main Menu Options

Menu item	Description
Waypoints/Task	Accesses NAV SD 's waypoints and Taskdefinitions. (see Section 4.1)
Task delay	Shifts all time parameters in the active task. (see Section 4.2)
TaskNavigator	Allows manual override of navigation. (see Section 4.3)
Critical Airspaces	This page constantly shows the airspaces which are closer than the thresholds defined in the settings (see Section 4.8.16)
Near Landings	Displays airfields page. This page constantly shows the glide ratios, and distances to the nearest landing fields, sorted by easiest glide. (see Section 4.5)
Flight log	Accesses the stored flights list. (see Section 4.6)
Pages	Accesses different layout pages. (see Section 4.7)
Settings	Accesses the Settings sub menu. (see Section 4.8)
Shutdown	Switches off the NAV SD , and displays detailed battery status.

4.1 Waypoints and Task

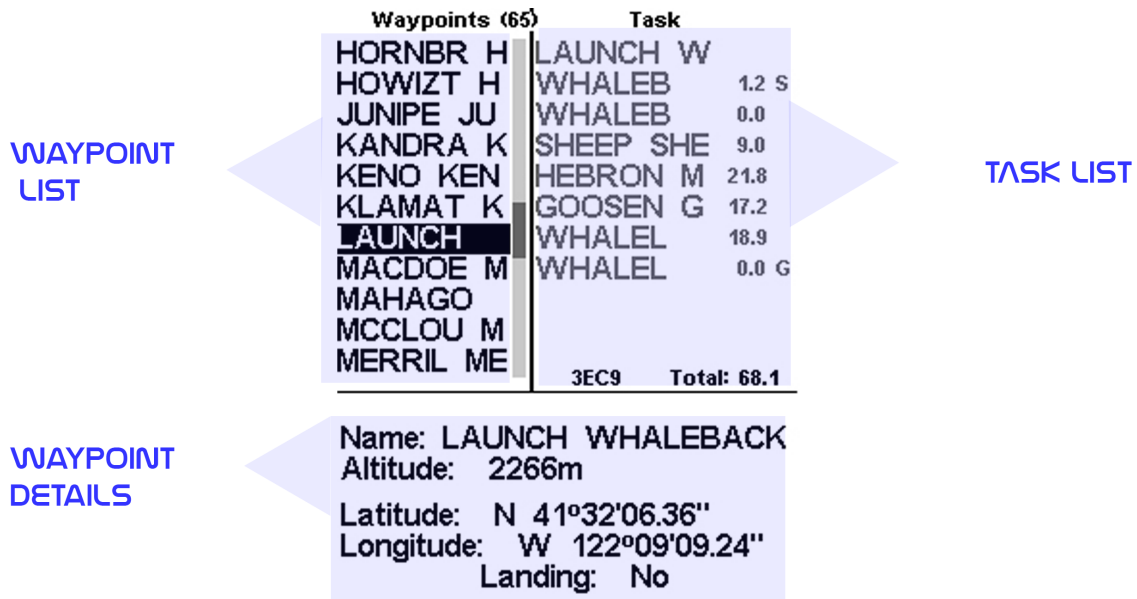

Figure 4.2: Waypoints and TaskScreen

The Waypoints/Taskpage allows the user to manage waypoints, and define a route/task. As shown in Figure 4.2, the page is divided into 3 areas, namely the waypoint list (WL); Tasklist (TK) and selected waypoint details/options list (DO). The DO area can change according to which submenu you are in. Specifically, it can show the selected waypoint data, or a list with possible actions for the waypoints. Entering the page activates the WL area. At the top of the page next to the title Waypoints, is the total number of Waypoints stored in the NAV SD instrument¹. The first waypoint on the list appears highlighted, and the corresponding data of the selected waypoint is shown in the DO area. As the cursor is moved to a different waypoint so the data changes matching the newly selected waypoint. If the waypoints list is empty a list of available actions is shown in the DO area. Since no waypoint exists only the *Insert new Waypoint* action is available.

Pushing the ENTER key when a waypoint is selected activates the waypoint actions menu (WAM). A list with the available actions is shown in the DO area Figure 4.3.

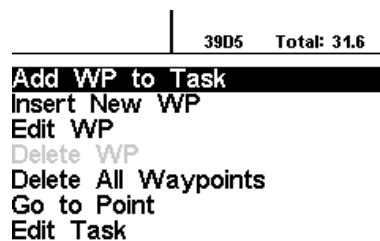

Figure 4.3: Waypoints Action Menu

Available WAM options appear in black, otherwise in grey. For example, in Figure 4.3 the option *Delete WP* is not available because the Waypoint list is empty.

¹The NAV SD can store up to 442 waypoints.

4.1.1 Waypoints Actions Menu

On entering the waypoint actions menu (WAM) the selected waypoint becomes grayed indicating that waypoint specific actions will be carried out using the selected waypoint. Once the WAM is active a list of options appears in the DO area. A short description of each option is show in Table 4.2.

Table 4.2: Waypoint Menu Options

Action	Description
Add WP to Task	Adds the selected waypoint to the end of the Task.
Insert New WP	Starts a new waypoint entry. The current location is automatically used for default waypoint data.
Edit WP	Start editing the selected waypoint.
Delete WP	Delete the selected waypoint. If the waypoint is being used in the Task this option is disabled.
Delete all waypoints	Deletes all waypoints and Task.
Go to Point	Forces navigation to the selected waypoint. This overrides the task navigation.
Edit Task	Starts editing Task. If no waypoints have been added to the task this option is disabled.

Add Waypoint to Task

To add a waypoint to the Task, select the waypoint that is to be added by pressing either the UP or DOWN buttons until the desired waypoint is highlighted. Pressing the ENTER button will add the point onto the TL on the right, at this moment the task point options for the newly added waypoint will appear in the DO area, allowing to set several aspects of the task point (these can also be edited later).

Insert New Waypoint

This menu allows the user to add a new waypoint to the waypoint list. If the GPS is fix, then the co-ordinates and altitude used for the waypoint are based on the current position.

Edit Waypoint

Entering this menu allows the properties of the selected waypoint to be changed. The name of the waypoint can be changed, along with the elevation, latitude, longitude and if the waypoint is to be designated as a landing field. To change any of the properties of the waypoint, first select the waypoint. Pressing S2 pulls up the menu allowing the waypoint to be edited. Pressing the S2 button again will show a cursor as shown in Figure 4.4, indicating the character to be edited. Characters can be changed using either the S3 or S4 buttons. Pressing the S2 button will move the cursor to the next character.

Waypoints (63)	Route
STEWAR	WHALEB
TICKNE TI	WEED WE 21.5
TIONES TI	
TULELA T	
USFS42 US	
WEED WE	
WHALEB	
WHALEL	
WILLOW	
YELLOW Y	
YREKA YR	
	1424 Total: 21.5

Name: **WHALEB WHALEBAC**
 Altitude: **02579m**
 10 N 571690
 4597757
 Landing: No

Figure 4.4: Edit Waypoint

The waypoint may also be configured as a *Landing*, these waypoint will then be displayed in the Nearby-Landings (see Section 4.5).

Delete Waypoint

It is possible to delete just a single waypoint on the NAV SD . Select the waypoint to be deleted by pressing either the S3 or S4 buttons. Once the waypoint is highlighted, selecting *Delete Waypoint* will remove the waypoint from the NAV SD memory. If a waypoint is in use in the Task the delete function will be disabled, to delete the Waypoint it must firstly be removed from the Task.

Delete All Waypoints

All of the waypoints can be removed from the NAV SD . Delete all the waypoints will also delete the Task. When selecting this option the NAV SD will prompt to ensure that this is exactly what is intended. ²

Go To Point

Selecting the *Go To Point* will force navigation to the selected waypoint. Once selected (by pressing the ENTER button), the instrument will jump to the *flight screen* automatically and navigate to that point. When returning to the Waypoints/Task will cancel the active *Go To*.

The *Go To* function will override the Task navigation, although the NAV SD will remember where it was in the Task, so when the *Go To* is canceled (as described above) it will resume the Task at the point it was at before the *Go To* was activated.

Edit Task

The NAV SD will only store one Task. This is deliberate to prevent flying an incorrect Task. A Task can be edited by selecting the *Edit Task* option of the WAM. Selecting the *Edit Task* option will highlight the first Taskpoint in the TL area.

4.1.2 TaskList

The *TaskList* contains all the Taskpoints and allows to define their parameters in the task. Pushing the UP or DOWN buttons will move between the Taskpoints. For the highlighted *Taskpoint*, the DO area will display the *Taskpoint* parameters. ³ When a Task has only one point it is considered as a *Go To* type

²WARNING: Do not confuse this function with *Delete Task*. The last thing you want is to be sitting on takeoff with no waypoints in the NAV SD , to clear the previous Task use the *Delete Task* function described in section Section 4.1.2.

³WARNING: Whenever a modification is done to the Task, navigation will be restarted at the beginning of the Task.

route. The NAV SD will automatically start navigating to that point.

Note: When the Task contains more than one point then the first turn point will automatically be set as *Take-Off*. The *Take-off* is ignored for navigation purposes and is only used for calculating the total task distance.

Pushing ENTER while on a selected Taskpoint will open a *TaskPoint Menu* in the DO area (at the bottom of the screen), which will allow you to *Edit*, *Move* or *Remove* a point from the Task. Each *Taskpoint* defined has a particular type, by default it will be set to Cylinder (see Table 4.3 for a description of the various task point types) .

Table 4.3: Task point types

Type	Navigation
Take off	This first task waypoint is automatic defined as Take-Off. This waypoint, however, is only a place marker for calculating the entire task length. The NAV SD will ignore it for navigation purposes.
Cylinder	The cylinder type is defined by a coordinate and a radius. The coordinate is taken from the chosen waypoint and the radius can be defined by the user. The default value (usually 400m) for the radius is defined in the Turnpoint Size settings. During navigation, NAV SD will advance to the next task waypoint once the pilot transitions over the cylinder line.
Start In/Exit	Start In route waypoints are start gates, sometimes also known as <i>Exit start</i> . The start is defined by a coordinate, a radius, and time (start time). NAV SD will only validate the waypoint, and advance to the next waypoint on the route, if the user is inside the set radius after the start time (Cross the start line after the start time). Note that the sequence in which this waypoint appears in the task list is very important.
Start Out/Enter	Start Out is the most commonly used start gate, sometimes also known as an <i>Entry start</i> . NAV SD will only validate this waypoint, and advance to the next waypoint, when the user is outside the radius after the start time (Cross the start line after the start time). The start is defined by a coordinate, a radius, and time (start time). Note that the sequence in which this waypoint appears in the task list is very important.
End Speed Section	Frequently, the task time stops before the end of the task (Goal). The point where the time stops is the End of Speed Section (ESS). The ESS can be a cylinder, defined by a coordinate and radius, or a Cone defined by a coordinate, a radius, and a ratio (cone ratio). Both ESS types have a time parameter.
Goal Cylinder	The goal cylinder is very similar to the Cylinder, except for the fact that it has a <i>Closing Time</i> . The closing time is used to calculate the Goal Close user defined field.
Goal Line	A goal line is defined as a line, with a specific length and centered in a coordinate. By definition the line is perpendicular to the direction taken from the previous task waypoint to it. A Goal Line with length of 400m will extend 200m either side of the centre of the co-ordinate that is designated as a goal line.
Landing	Most of the times landings can take place at the Goal. In this case the Goal point may be inserted again which allows the definition of a Landing limit time. The NAV SD will then use this limit to calculate the <i>Land In</i> data field. On some occasions, for safety reasons, landing is recommended to be elsewhere, so a different waypoint may be used.

When the NAV SD validates a turnpoint it emits a audible notice informing the user that navigation has advanced to the next waypoint, this audible notice can be disabled in the Alerts setting (see Section 4.8.4).

Edit route point

When *task points* are added to the task by default their type is Cylinder and have a 400m radius, (except for the first one, as mentioned above, which is set as *Take-off*).⁴ To modify a particular *task point*, select the task point using the UP or DOWN buttons, then push ENTER to open the Task Point Menu. Finally select the *Edit Route Point* and push ENTER. The task point parameters can now be edited. Changing the *task point type* will cause the *Time* field to be displayed when applicable.

Very important: The sequence in which the waypoints are listed is critical since the NAV SD will navigate them in that order, so in the case of a start gate which is also a turn point (as is commonly used in competition tasks) the start must be placed before the turn point.

The *Time* is only available on turn point types that are time related, so the *Time* field will only be visible when the turn point type requires a time (e.g. Start gates and goals). Table 4.4 describes how *Time* data is used for each field type.

Table 4.4: Task time types

Type	Time field
Start out or Start in	The time at which the start opens. The start is only validated when the pilot crosses the perimeter line at a time later than the defined time. The TTG (time to go) will show how much time remains to the opening of the start, i.e the difference between this field's value and the local time of day. Navigation to next point will only continue after the validation of the start.
Goal Cylinder or Goal Line	Time of goal close. The <i>Goal Close</i> data field displays how much time is left until the close of the goal.
Landing	Time of compulsory landing. The time will be used to calculate the <i>Land In</i> user defined field.

Move Route Point

The order of a task point can be easily changed. To change the order simply select the waypoint using the UP, and DOWN buttons. Push the ENTER button to activate the actions menu list. Then select the *Move Route Point* option, and push ENTER button. A cursor will be shown next to the selected waypoint. Using the UP and DOWN buttons move the task point to the desired position and push ENTER.

Remove Route Point

To remove a task point select it using UP, and DOWN buttons, and then pushing the ENTER button to activate the Task Point Menu, chose the *Remove Route Point* option and push ENTER to remove it from the list.

Delete Task

Delete Task will delete the entire route. On any waypoint push the ENTER button to activate the actions menu list. Select the *Delete Route* option from the menu, and push the ENTER button to confirm. The route will be deleted and the WL area activated.

⁴The default radius can be modified (see Section 4.8.15).

View Task

Entering the *View Task* menu shows the task along with the optimised route as shown in Figure 4.5. This view has a number of important features displayed. The start time is shown in TP1 and the optimised route is shown by following the sequential waypoints. The size of the cylinders is also shown along with a scale at the bottom left of the screen. The total optimised distance for the task is show at the top of the screen. Since this is optimised distance it will be less than the distance shown in the *Task List*.

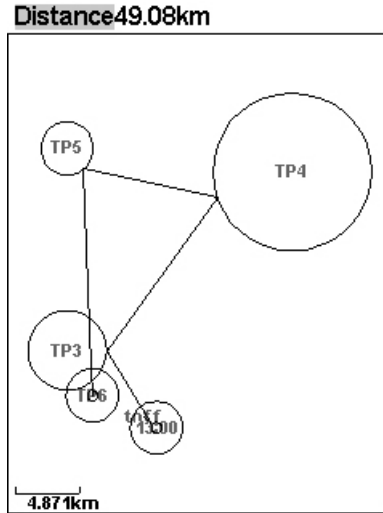

Figure 4.5: Task View

4.2 Task Delay

During competitions it is common that the tasks gets postponed or delayed. Usually the take off, the start gate, goal close and land by times are all postponed or delayed. Instead of having to edit the defined task, the NAV SD offers a task delay feature which moves all defined times in a task forward by X minutes.

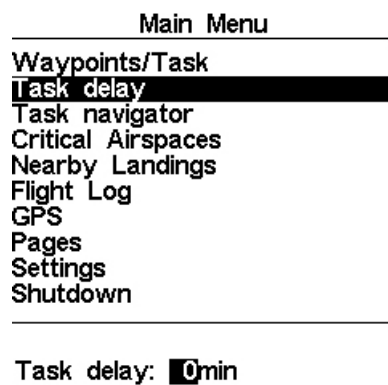

Figure 4.6: Task Delay

To delay a task, when in the *Task Delay* menu simply push the ENTER button when the *Task Delay* is selected (Figure 4.6). Then using UP, and DOWN buttons set the number of minutes to delay. Finally, push the ENTER button to confirm.

4.3 TaskNavigator

This function is useful to override the automatic task navigation provided by the NAV SD , and should only be used if for some reason a mistake was made during the creation of the task.

When this option is selected the NAV SD displays the task list. Using the UP and DOWN buttons the desired waypoint can be selected. Pressing the ENTER button will cause navigation to be resumed to the selected waypoint. Route navigation will then continue in the sequence displayed in the task menu.

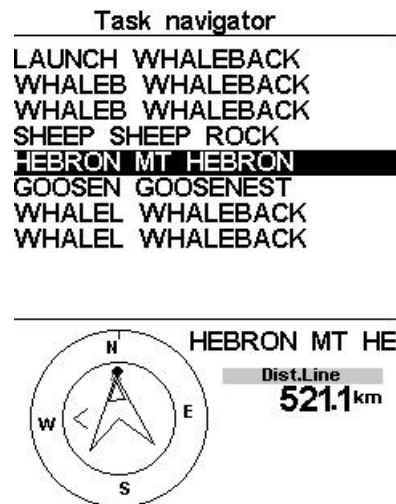

Figure 4.7: Task Navigator

When entering into the Task Navigator menu, all of the route points are shown as both the short name and long name (Figure 4.7). Selecting any of the routepoints will show a navigation wheel in the lower part of the screen showing the direction to that point along with the distance to the waypoint cylinder. The distance shown is the Distance to Line, which is the closest point on the cylinder to where the pilot is. This is not necessarily the optimum point on the cylinder.

The *Start* waypoint will be grayed since it is not possible to navigate to a start. Pressing the menu button will get you back to the flight screen without any change to the navigation.

Note: An override to the navigation will assume that the start has been done.

4.4 Critical Airspaces

Critical airspace shows a list of airspaces that are closer from the pilot's position than the distance and altitude thresholds defined in the Airspace Settings (see Section 4.8.16)). This list is generated when in flight mode and is ordered by the sequence in which the airspace appears in the file used to create the airspace. For example, if the altitude, and distance threshold is set to 200 meters then all the airspaces that are closer from the pilot's position than 200 meters are shown on the Critical Airspaces list. A typical list of airspace may look like Figure 4.8. Note that the number in parentheses indicates the number of airspace polygons loaded into the instrument.

```

Critical Airspaces (238)
SALINAS CLASS D
MONTEREY PENINSU
SAN CARLOS CLASS
SAN CARLOS CLASS
SAN JOSE AIRPORT
SAN JOSE AIRPORT
METROPOLITAN OAK
METROPOLITAN OAK
HAYWARD CLASS D
LIVERMORE CLASS
    
```

Figure 4.8: Critical Airspace

If a critical airspace is selected by pressing ENTER key, the lower field is populated with the airspace data (Figure 4.9). This list shows:

- the Distance to the CTR (see Section 4.8.16),
- the Altitude which is the reference altitude for the airspace (see Section 4.8.16),
- the floor of the airspace which is the lowest altitude of the airspace,
- the ceiling which is the maximum altitude of the airspace.

The list also shows the airspace status, specificity if the pilot is violating airspace, or the violation is imminent, or if it is out of airspace. In the example of Figure 4.9 the pilot is out of the airspace. The reference altitude is the current altitude being used for airspace calculation. Different reference altitudes can be set in the Airspace settings (section 15.15 Airspace settings) and these include Altitude (barometric altitude), GPS altitude and Flight Level (using 1013.25 mBar pressure). For more details on this see Section 4.8.16.

```

Critical Airspaces (238)
SALINAS CLASS D
MONTEREY PENINSU
SAN CARLOS CLASS
SAN CARLOS CLASS
SAN JOSE AIRPORT
SAN JOSE AIRPORT
METROPOLITAN OAK
METROPOLITAN OAK
HAYWARD CLASS D
LIVERMORE CLASS
-----
Dist_CTR  -----  out
Altitude   -100ft
Floor      1499ft
Ceiling    3999ft
    
```

Figure 4.9: Critical Airspace Data

4.5 Nearby Landings

It is possible to define waypoints as *Landing*, allowing the pilot to quickly check for landing options. The Nearby Landings page will show all the waypoints, defined as *Landings*, for which the necessary glide ratio is finite. Glide ratio's are calculated once the Flight Starts. Besides the waypoint name the distance and glide ratio are also shown. The list is sorted by glide ratio in ascending order (see Figure 4.10). On the

example of Figure 4.10 the closest airfield is 12.48 Km from our present location, and the necessary glide ratio to reach it is 9.6. The Nearby Landings page can also be used to make a *Go To*. Use the UP, and DOWN keys to select the desired waypoint, then push the ENTER key to immediately activate navigation to the selected waypoint. In order to define a waypoint as a landing the *Landing* parameter should be set to *Yes* in the waypoint edit screen (see Section 4.1.1).

Note: The Nearby Landings page can be accessed directly from the Flight Mode screen, by using a short cut function key (see section Section 4.8.14).

Near Airfields		
B006	12.48	9.6
B003	15.25	11.8
B004	15.68	12.1
B007	23.13	17.8

Figure 4.10: Nearby Landings

4.6 Flight Log

The Flight Log option allows the user to access information about previous saved flights (Figure 4.11). The top half of the screen lists flights stored in memory. Each flight is identified by the take off date, time and flight duration.

Flight Log		
2012-11-28	23:30:38	00:02:34
2012-11-24	21:52:54	00:49:05
2012-11-24	04:52:21	00:00:13
2012-11-23	19:08:41	00:00:08
2012-11-23	17:20:09	00:00:43
2012-11-21	20:44:03	00:00:12
2012-11-10	14:11:42	01:15:02
2012-10-05	09:43:25	00:12:44
2012-10-03	10:41:36	00:00:09
2012-10-01	12:17:32	02:28:48

Max.Alti: 4911m
T.off Alti: 2540m
Above Toff: 2370m
Max.Sink: -3.7m/s
Max.Climb: 4.4m/s
Max.Speed: 63.0km/h
Distance: 47.61km: Goal
Speed Sec: 02:03:20

Figure 4.11: Flight log

Flights can be selected using UP and DOWN keys. For the selected flight additional information is displayed on the bottom half of the screen:

- Max. Altitude - Maximum altitude during flight (ASL).
- T.off Alti. - Take off altitude.
- Above Toff- Altitude above take off

- Max. Sink - Maximum sinking rate during flight
- Max Climb - Maximum climbing rate during flight
- Distance - Distance flown and if goal was made
- Speed Sec - Time to cover the speed section of the task

Pushing the ENTER key will display the Flight Log Action List, with options:

- Delete flight
- Delete all flights

Each of the options is explained in the following sections.

Also if you use a flight data download application and request the flight list while the Flight Log Action is active only selected flight will be reported to the downloader application, this is useful at competitions to ensure the scorer downloads the correct flight.

Delete Flight

Selecting the *Delete Flight* option will delete the selected flight from memory. Before deleting the flight, a message is displayed asking the user to confirm the action (Figure 4.12).

```
Flight Log
-----
2011-12-16 17:17:04 01:38:46
```

```
-----
Delete flight

Are you sure?: No
```

Figure 4.12: Delete Flight

Delete All Flights

All of the flights in the NAV SD can be deleted by selecting the *Delete all flights* option. A message is displayed asking the user to confirm the action of deleting all flights (Figure 4.13).

Flight Log		
2012-12-01	00:21:09	02:48:27
2012-11-30	03:10:45	00:23:19
2012-11-29	04:28:28	00:21:33
2012-11-29	03:40:52	00:01:01
2012-11-29	02:46:16	00:16:02
2012-11-29	02:03:18	00:10:58
2012-11-29	01:40:20	00:15:17
2012-11-29	01:25:00	00:05:45
2012-11-28	23:39:34	01:44:26
2012-11-28	23:30:38	00:02:34

Delete all flights

Are you sure?: **No**

Figure 4.13: Delete all flights

WARNING: Deleting all flights will completely erase the flight log memory, all track logs will permanently erased.

Memory capacity

The current firmware version can store up to 131000 points (without data from Flymaster accessories, like HEART-G, or TASProbe), which equates to over 36 hours with a 1 second recording interval (obviously if you set it to a 10 second recording interval you get 360 hours). See Section 4.8.2 on how to change the interval.

Also important to understand is how the data is organised, there are 256 blocks of data which can handle 510 points each, as a flight grows it takes up these blocks, so each flight will occupy a multiple of 510 points, at an extreme example if you have 256 flights each with 1 second the memory will be full, and you only have 256 seconds of flight data (this is obviously not a realistic scenario).

4.7 Pages

The Pages Menu shows a list of the current Layout pages that are available on the NAV SD . Furthermore, the pages Menu can be used to switch page, or to Disable/Enable each of the available pages. A Layout can include 16 different pages, and all of them can be drawn using the Flymaster DESIGNER software. Figure 4.14 shows an example of what is available in a typical layout in the Pages Menu (this will be different depending on what was drawn with the Designer).

Pages
P0- R2G B4 start
P1 R2G after start
P3 Open distance map page
airspace page
landing page

Figure 4.14: Available Pages example

You can select different pages by selecting either the UP or DOWN keys. If you press ENTER for a certain page, 2 options become available as shown in Figure 4.15.

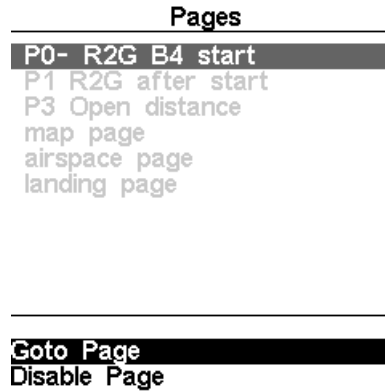

Figure 4.15: Page Options

Selecting the *Goto Page* option and pressing the ENTER button will jump to that page on the *Flight Screen*. This allows the user to display any of the pages without having to resort to trigger functions to display that particular page or having to scroll through all of the pages in sequence using the a function key. It is also possible to disable a page so that when you toggle through the different pages, that page is not displayed (see Figure 4.16). Also all triggers associated with the disable page will be ignored.



Figure 4.16: Disable Page

Once a page is disabled, an asterisk will be shown on the pages list prior to the page name as shown in Figure 4.17 (in this case *P1 R2G after start* is disabled).

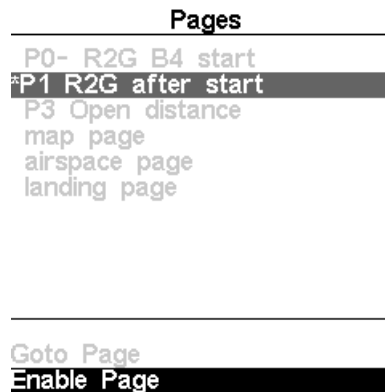

Figure 4.17: Enable Page

Note that on Figure 4.17 when selecting and pushing ENTER the *Goto Page* option is not active and the focus will be on the *Enable Page*. Pressing ENTER will re-enable the page.

4.8 Settings Menu

The *Settings Menu* is used to configure the NAV SD 's many features. The menu screen is divided into two sections. On the top of the screen all the menu options are shown. Depending on the menu option selected the associated configurable parameters are shown on the bottom of the screen (see Figure 4.18). The desired option can be selected using the UP and DOWN keys, and the corresponding parameters altered after pushing the ENTER key.



Figure 4.18: Settings Menu

Note that on the right hand side of the display is a scroll bar showing where the relative position of the displayed menu compared to all of the other settings available in this menu. All the menu options are explained on the following sections.

4.8.1 Set Altimeter

The *Set Altimeter* page (Figure 4.19) allows the user to adjust the barometric altimeter. A barometric altimeter calculates altitude based on atmospheric pressure, and should not be confused with the GPS altitude, which is calculated based on satellite information (See the article in <http://www.xcmag.com/2011/07/gps-versus-barometric-altitude-the-definitive-answer/> GPS versus Barometric Altitude). Since atmospheric pressure can vary substantially with meteorological conditions, and so with time, the barometric altitude also varies according. In order to have the correct altitude for a certain place the altimeter should be calibrated.

Calibrating the altimeter can be achieved by entering the know altitude of the location. Entering an altitude automatically calculates the QNH, which is the local barometric pressure adjusted to sea level. Alternatively, the altimeter can be calibrated by adjusting the QNH for the local, and time. Changing the QNH will adjust the barometric altitude.

Altitude can also be set from the GPS. Below the QNH you will find a *Get from GPS* field which can be set to *Yes No* or *Auto*. Adjusting this value to *Yes* will make the NAV SD take the altitude from the GPS and adjust the altitude accordingly. The *Yes* is not stored in the setting, since it is a one time only operation. The *Get from GPS* can also be set to *Auto*, with this value being stored in the settings. When *Auto* is selected, after being turned On, the NAV SD will automatically set the altimeter to the GPS altitude (once the a valid GPS signal exists), or whenever the pdop value is lower than the previous one. Note that *position dilution of precision* (pdop) gives you an indication of how reliable the *GPS* altitude is at the moment. The lower the pdop value the more accurate the position fix.

QNH: 1013.250
Get from GPS: No

Altimeter: 58m
Altitude2: 58m

Figure 4.19: Set Altimeter

4.8.2 Time

The *Time* page allows the user to set the vario integration time, track log parameters, and the Universal Coordinated Time ((UTC) offset). (Figure 4.20)

Vario Integr.: 10s
Track interval: 1s
UTC offset: + 00:00

Figure 4.20: Timing Parameters

The current firmware version supports two interval related parameters the *Vario Integrator* and *Track Interval*.

Vario Integrator

The Integrated vario is calculated by integrating the vertical speed during a period of X seconds defined by this value. In the example of Figure 4.20, the integration period is 10 seconds (default value).

Track interval

During flight the NAV SD stores a track log point every *track interval* seconds. Track recording starts automatically when the Flight Starts (see Section 1.7). However, when a task is active the NAV SD will store a track log point immediately as it enters a turn point cylinder, Goal, or Start. See Section 4.6 about track log memory capacity.

UTC offset

Using GPS data, the NAV SD automatically adjusts the internal clock to the Universal Coordinated Time (UTC). The user should adjust the UTC offset so that the time displayed by the NAV SD matches the local time.

4.8.3 Vario Acoustics

The *Vario Acoustics* settings menu option allows the user to change vario sound related parameters. The user can change the climbing, and sinking rate sound through the respective threshold values. These thresholds correspond to the climbing and sinking rates at which the sound activates. The user can also define in the Acoustic Thresholds option the sink alarm and the sound volume of is the NAV SD (Figure 4.21).

```

Sink TH: -2.0m/s
Climb TH: 0.1m/s
Sink Alarm: 0.0m/s
Base: 700hz
Increments: 10hz
Volume: 4)

```

Figure 4.21: Vario Acoustics

Climb Threshold

The *Climb Threshold* defines the rate of climb at which the vario will start beeping. The frequency of the first beep is defined through the [Base Frequency](#) parameter, and steadily increases according to the [Increments](#) parameter value.

The default value for *Climb Threshold* is 0.1m/s. This means that beeping starts once the instantaneous vario value goes above 0.1m/s.

Sink Threshold

The *Sink Threshold* is the rate of descent at which the vario will emit a low frequency sound. Contrary to the climb sound the sink sound is continuous. The deeper the sink rate the lower the sound frequency. Default value for this parameter is -2 m/s, we suggest setting a value lower than the natural sink rate of the glider when flying with speed bar in still air.

Sink Alarm

The *Sink Alarm* defines a vertical speed value at which a sound (alarm siren) starts to be produced. For example, if the *Sink Alarm* is set to -10m/s, then if the instantaneous vario goes below -10m/s, and alarm will be fired. This alarm can be used to identify high vertical speeds, as for example, in a spiral dive. The Sink Alarm parameter can vary from 0 to -25m/s. Set the Sink Alarm to *Off* to disable the alarm.

Base Frequency

The audio frequencies can be adjusted to match the user's preference, by setting the *Base Frq* and *Increments*.

The *Base Frq* is the first frequency used to produce the initial sound which corresponds to the climb threshold (by default 0.1 m/s). Later, as the climb rate increases, a bip, bip sound is produced for which the cadence, and frequency, also increase. The *Base Frq* can be set from 500 to 1500 Hz. The higher is the frequency value, the higher pitched the sound is.

In order to change the base frequency value press the ENTER key after the *Audio Frequencies* menu option is highlighted. This action will highlight the *Base Frq* value so it can be increased using the UP key, or decreased using the DOWN key. The ENTER key should then be pressed, thus confirming the *Base Frq* setting. The preset value for *Base Frq* is 700 Hz.

Increments

The *Increments* parameter sets the frequency increment for each 0.1 m/s climb rate increase. The *increments* can be set from 1 to 99 Hz. The preset value for *Increments* is 10 Hz.

Considering an *Increments* value of 10, and *Base Frq* of 700 Hz, the vario frequency at 1 m/s is 800 Hz.

Volume

The final option allows the user to adjust the sound volume. The NAV SD has six different sound levels, plus *no sound*. Pressing UP, or DOWN, keys will respectively increase, or decrease the sound level. After setting the sound value, to confirm and return to the Settings menu press the ENTER key. The new sound level is saved in memory and is used when the NAV SD is turned on. Sound volume can also be

adjusted using one FS key. However, the sound level adjusted using the FS key is not kept in memory, so is only valid until the NAV SD is turned off.

In *Flight Mode* the current volume level can be seen using the sound element (see Section 3.1.2 for more details).

4.8.4 Alerts

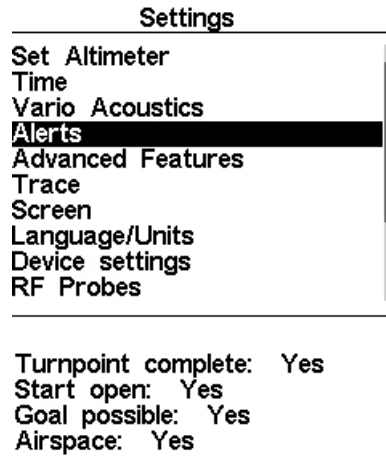

Figure 4.22: Alerts

In this menu it is possible to set up the instrument to give you audio alerts when certain conditions have been met. There are 4 different possible alerts (Figure 4.22).

Each of these alerts can be enabled by selecting the YES prompt when the ENTER key is pressed. Conversely, selecting NO will disable the respective alarm. The description of each alarm can be seen in Table 4.5

Table 4.5: Alerts Types

Alerts	Messages
Trunpoint Complete	A alarm (brrrr sound) is produced when the pilot successfully cross a turnpoint (see Turnpoint validation)
Start Open	A siren type sound is produced when the start time elapses. <i>This tone does not indicate that a successful start has been made just that the Start is open.</i>
Goal Possible	A alarm (brrrr sound) is made to indicate that it is possible to reach GOAL. This is based on having a positive number for <i>Arrival Goal</i> . This is calculated based on the average glide ratio and it takes into account wind.
Airspace	A siren type sound is produced indicating that the pilot has entered the buffer zone (see Section 4.4) close to airspace.

4.8.5 Advanced Features

The advanced features settings option can be used to set more of the NAV SD vario acoustics. (Figure 4.23).

```

Damper: 6
Cadence: 1
Dynamic freq: On
Buzzer: 3
Auto Silent: On
Start Speed: 1

```

Figure 4.23: Advanced Features

Damper

The NAV SD's vertical speed calculation is based on air pressure variations. It is very seldom to have air pressure absolutely stable. Turbulence caused by air moving near the sensor is sufficient to cause small variations in pressure. For this reason the NAV SD filters (averages) the pressure data to prevent constantly detecting tiny pressure variations. The value that defines how much the pressure is filtered is the *Damper*. Setting a lower damper value causes the NAV SD to become more responsive but harsher. Inversely a higher value causes the NAV SD to be less responsive but smoother. The default value is 6.

Cadence

When a rate of climb is higher than that specified by the Climb threshold the NAV SD creates a beeping sound. The rate (cadence) of the beeps increases as the climb rate increases. This increase in rate is not linear. The cadence parameter specifies which cadence curve should be used. Currently there are 2 possibilities represented in the graph of Figure 4.24.

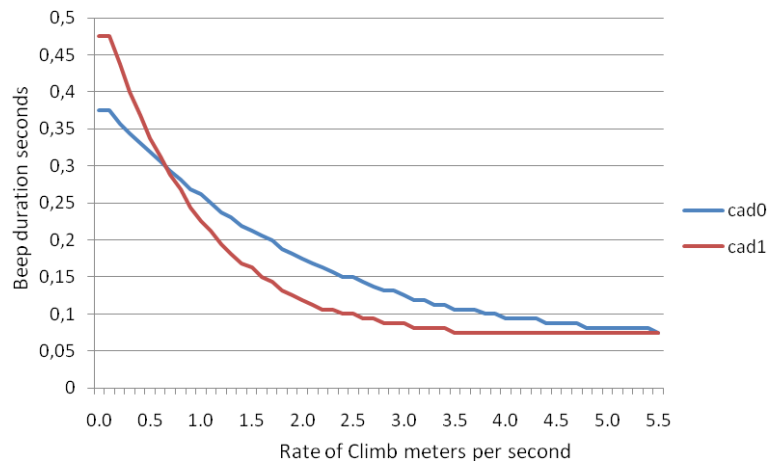

Figure 4.24: Cadence timing

Dynamic Frequency

The NAV SD beeps at a specified pitch (frequency) when a certain rate of climb is encountered. When dynamic frequency is off, the pitch (frequency) of that beep will remain constant if the rate of climb changes. With dynamic frequency on, the pitch of the beep may vary if the rate of climb varies during the individual beep.

Buzzer

Is so called because of the sound it emits, which resembles a buzzing sound.

The buzzer sound is produced when the rate of climb is close to, but has not yet reached the specified Climb threshold (see 13.3.1). This value is set between 0 and 9 with each unit corresponding to be 0.1 m/s, ie. 3 is 0.3m/s. Subtracting this decimal value from the climb threshold will give us the value at which the NAV SD will start buzzing. For example with the NAV SD default values, Climb threshold=0.1m/s, and Buzzer=3 (0.3m/s) the buzzing will start at -0.2m/s because $0.1 - 0.3 = -0.2$. In this case at 0.1m/s directly below the Climb threshold the NAV SD will emit a constant sound varying rapidly in pitch from around 100hz to the set base frequency at which the first beep is emitted. This is the buzzer sound and may resemble a growl noise. Setting the Buzzer value to *Off* will disable the buzzer feature.

Although the Buzzer will sound very annoying on the ground it becomes an amazing companion in flight allowing the pilot to pick-up thermals he would have usually missed.

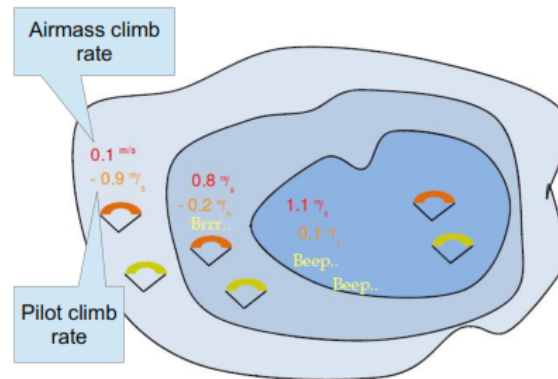

Figure 4.25: Buzzer

A practical example of the advantages of the buzzer feature can be illustrated in Figure 4.25. In this example both pilots are sinking at -1.0 m/s. The orange paraglider has a NAV SD for which the climbing threshold is set to 0.1 m/s and the Buzzer parameter is set to 3 (0.3 m/s). The green paraglider has a typical vario for which the climbing threshold is set to 0.1 m/s.

As shown in the figure, when both pilots enter the thermal nothing is heard. The air is rising at 0.1 m/s but both pilots are descending at -0.9 m/s. In the second zone of the thermal the air is rising at 0.8 m/s, and so pilots are descending at -0.2 m/s. At this stage the orange pilot starts to hear the Buzzer brrrrr sound of his NAV SD, which helps him to center the thermal, while the green pilot is still unaware of the thermal. Finally, in the 3 zone, the air is rising at 1.2 m/s, and so both pilots climb at 0.2 m/s. The NAV SD pilot starts to hear his vario beep... beep... sound, and it is only at this point the green pilot hears the first beep from his instrument.

Auto Silent

Setting *Auto silent* option *ON* will keep the NAV SD's buzzer quiet until a *Start Flight* has been detected. (see Section 1.7) This function avoids listening the vario sound while waiting to take off. The audio will then be kept active until the NAV SD is switched off. The default value for the auto silent parameter is *ON*.

Start Speed

The *start speed* is one of the *Start Flight* conditions, and it is used to define the minimum GPS speed, in Km/h, that should be reached in order to initiate the flight. Note that the *Start Flight* event is important to many other functionalities, so care should be taken when setting this value. For example, if *Auto Silent* is on, the vario will only beep after the flight starts. The track data is also only saved after the flight starts.

4.8.6 Trace

This option sets the behaviour of the traces drawn on the Map view (see Figure 4.26).

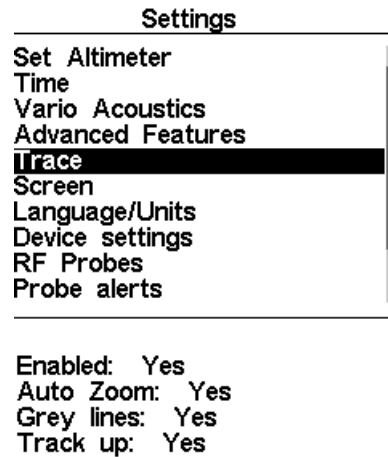

Figure 4.26: Trace Settings

Enabled

Setting this option to *Yes* will draw traces on the Task Map, setting *No* a trace will not be drawn.

Auto Zoom

Setting *Yes* causes the system to automatically zoom into the trace when entering a thermal, making it easy to understand the location of the thermal.

Grey lines

Set *Yes* the trace lines in lift will be drawn in black while the sink will be drawn in grey. Set to *No* and all the trace lines will be drawn in black.

Track up

Track up allows the trace to be displayed with either the track relative to North (see Figure 4.27) or with the current heading to the top of the screen (see Figure 4.28). When *Track UP* is *Off* you will see the map turning around the pilot, while with *North UP* you will see the pilot moving around the Map.

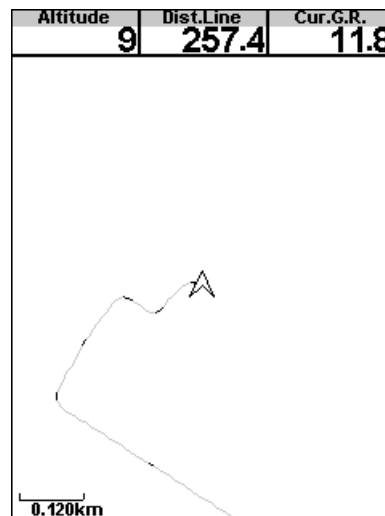

Figure 4.27: Track Up Off

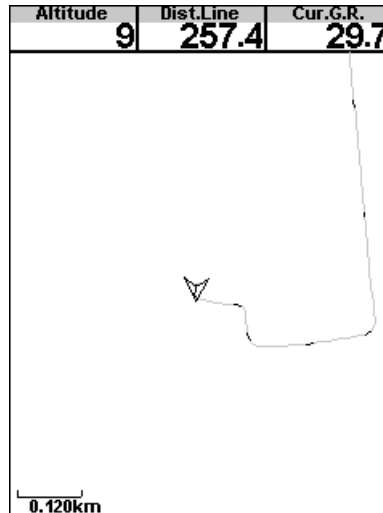

Figure 4.28: Track Up On

4.8.7 Screen

The screen menu option allows the user to set the Screen contrast to Enable/Disable the pages triggers, and to colour-invert the titles(Figure 4.29).

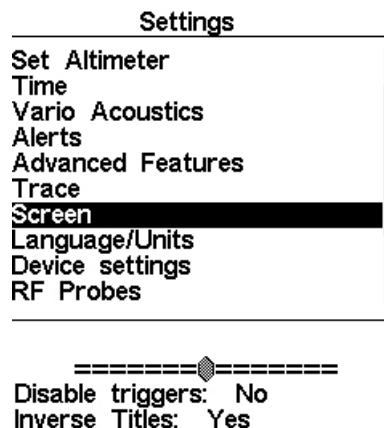

Figure 4.29: Screen Settings

Screen Contrast

Contrast may be adjusted to the pilot’s needs. You can use the UP, and DOWN keys, to move the contrast bar (Figure 4.29). Move the bar to the right to increase the contrast, and to the left to decrease the contrast. When in the desired position push the ENTER key to confirm the value.

WARNING: Beware of adjusting a very low contrast value may cause the display to be totally blank. With a blank screen it is difficult to readjust since nothing is visible.

Disable Triggers

Page event triggers are a important unique feature of the NAV SD . Pages can be automatically activated (switch to) during flight by associating one of the pre-defined trigger events with the page. Triggers are set using the Flymaster DESIGNER program (See the DESIGNER manual for details). Each trigger is

Table 4.6: Page Triggers Events

Event	Description
Airspace Warning	This event occurs when the horizontal, or vertical distance to an airspace is less then the respective thresholds.
Entering Thermal	This event occurs when the pilot enters in a thermal. A thermal is detected when the integrated vario is greater than 0.5m/s and the rate of turn is greater than 10
Transition	This event occurs when the pilot enters leaves a thermal and starts a transition. A transition is detected when the integrated vario is less than 0.5 m/s and the rate of turn less than 5
Arriving at Turnpoint	This event occurs when the pilot is arriving at less than 1km away from the turnpoint
Start Opened	This event occurs immediately after the start time.
Power Up	This event is triggered when the instrument is powered up.

fired when certain conditions are met. If a trigger is fired the NAV SD switches to the associated page automatically. For example, consider that page 3 is associated with the trigger *Airspace Warning*, and the current displayed page is page 2. If during flight an airspace limit is reached the device will automatic change the page 3. The current available triggers for the NAV SD are show in Table 4.6.

This menu can also be used to disable all the page triggers at once. In order to disable page triggers the *Disable Triggers* option should be set to *Yes*, using the UP, or DOWN keys, and confirmed with the ENTER Key.

Inverse Titles

Inverse titles allows the user to change the background of the titles as illustrated in Figure 4.30.

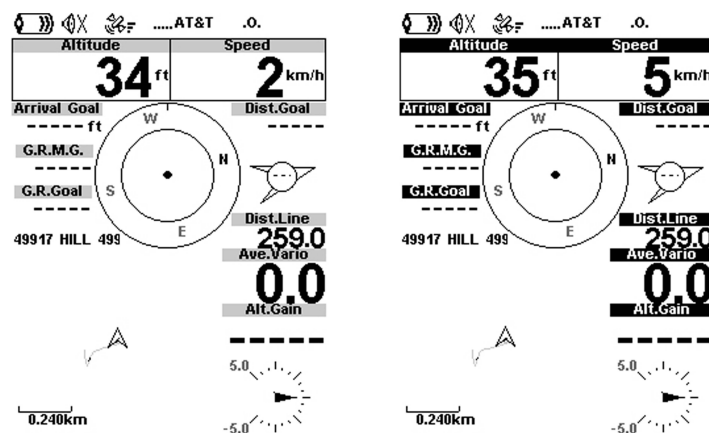

Figure 4.30: Inverse Titles

The figure of the left shows the normal display and that on the right shows the same display with inverse titles set to *Yes*.

4.8.8 Language/Units

The *Language and Units* menu option allows the user to change the NAV SD interface language and units. A short description of the available options for this menu are shown in Table 4.7. The UP, and DOWN keys, can be used to change each field option. Pushing the ENTER key confirms the current field value, and highlights the following field. Pushing, the MENU key will undo changes.

Table 4.7: Language/Units Menu Options

Function	Description
Language	Defines the interface language.
Alti. Units	Altitude Units. Altitude can be show in Meters, or Feet.
Roc. Units	Rate of Climb Units. ROC can be show in m/s, or 10 x Feet/ min
Dist. Units	Distance units can be in Km, or Miles.
Speed Units	Speed Units can be in Km/h, Miles/h, or Knots.
Temperature	Temperature units can be Celsius or Farenheit.
Coords.	Coordinates format. These can be either: <ul style="list-style-type: none"> • DD°MM'SS' • DD°MM.mmm' • DD.dddd • UTM

4.8.9 Device Settings

This menu option allows the user to execute some recovery functions. A short description of the available options is shown in Table 4.8.

Table 4.8: Device Settings

Function	Description
Factory Settings	Reset all parameters to the default factory values. This will not change the layout to the factory default layout. Care should be taken because all changes made by the user are lost.
Reset now	Makes a hardware reset to the instrument. The result is the same as the one presented in Section 1.5.
Auto-off	If set to <i>Yes</i> the NAV SD turns off if the GPS speed is less than 5 km/h, and integrated vario less than ± 1.5 m/s, for more than 30 seconds.

4.8.10 RF Probes

The *RF Probes* menu option allows the user to pair up any of the Flymaster wireless devices including the M1 and Heart-G to the NAV SD . Pairing is performed automatically. When ENTER is pressed the NAV

SD will look to see what wireless devices are around and it will show these on the screen (see Figure 4.31). Devices are identified by their name (e.g. M1, TAS) and serial number. Devices can be selected using the UP, or DOWN keys. For the selected (highlighted) device the pairing state is shown on the bottom of the screen. To pair a device the state should be changed from *No* to *Yes*. Once paired the NAV SD will always automatically connect with the wireless device. The NAV SD can be paired with several devices.

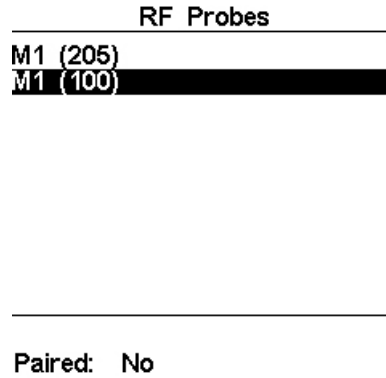

Figure 4.31: RF probes

In the example shown in Figure 4.31, two M1 devices are visible. These are distinguished on the screen by showing their serial number. (The serial number for the device can be found on the back of the wireless device). By selecting one of the M1 devices and selecting ENTER, the option to pair that device becomes available.

4.8.11 Probe Alerts

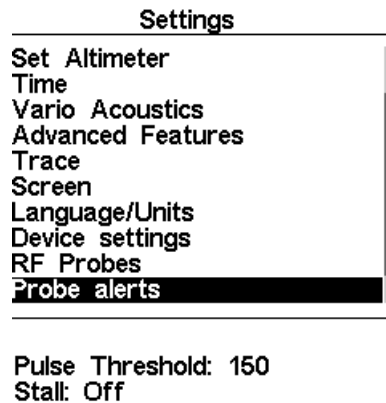

Figure 4.32: Probe Alerts

The NAV SD allows relating alerts with some probes values (see Figure 4.32). A short description of each alert is shown in Table 4.9.

Table 4.9: Probe Alerts

Alert	Description
Pulse Threshold	Pulse Threshold above which the pulse data field will toggle between inverted numerical display and normal numerical display. This allows the user to quickly see that they have a pulse above the desired level..
Stall	IAS speed value starting which a alarm is triggered (TAS Probe needed).

4.8.12 Polar

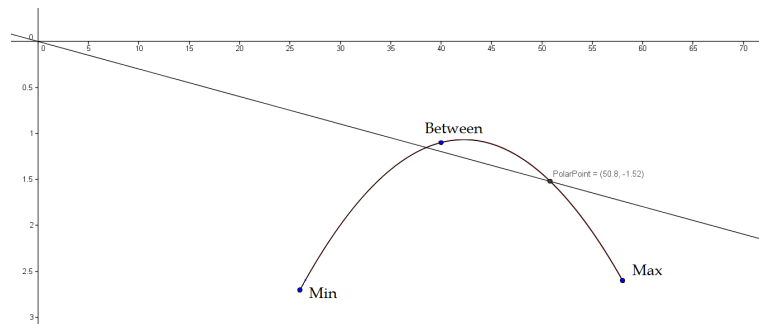

Figure 4.33: Polar Parabola

The *Polar* menu option allows the user to define the glider polar curve. The polar curve is approximated by a parabola which is defined by 3 points identified by *Max*; *Between*; *Min* (see Figure 4.33). Each point corresponds to a pair <horizontal speed in km/h, vertical speed m/s> where both values are positive, that are defined by the user (see Figure 4.34). In order to avoid errors the *Max* and *Min* points should correspond respectively to the maximum and minimum horizontal speed of the glider. The point *Between* should be some point between the Maximum and Minimum.

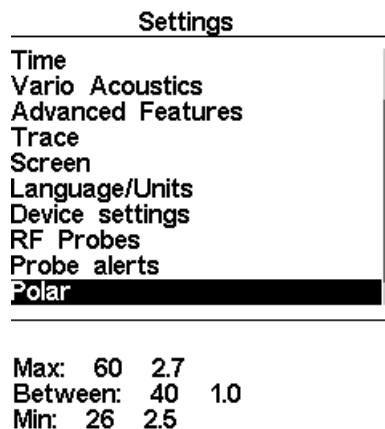

Figure 4.34: Polar

4.8.13 Data fields

The NAV SD has 6 user defined fields (UDF) which the pilot can configure for his own needs using this menu. UDF's are numbered from 1 to 6. A description of available data Fields can be found in Section 3.2. If UDF data fields are set up in the current layout, then this menu can be used to defined which data fields are shown in each of the 6 UDF's (Figure 4.35).

UDF 1: Vario
 UDF 2: G.R.Next
 UDF 3: Cur.G.R.
 UDF 4: G.R.Goal
 UDF 5: VMG
 UDF 6: G.R.M.G.

Figure 4.35: User Defined Fields

Entering this menu automatically moves the user to UDF 1. By pressing either the UP or DOWN keys, the user can select which data field is displayed. Pressing ENTER, will toggle to the next UDF. When all six UDFs have been set, pressing ENTER will save the settings.

4.8.14 FS Keys

In Flight Mode keys UP, DOWN, and ENTER can have user defined functions which provides shortcuts to certain functions. This menu allows the user to associate a function with a button. The functions in Table 4.10 can be allocated to the FS keys.

Table 4.10: Function Key descriptions

Function	Description
Set Volume	Scrolls trough volume level. The new level is kept until the NAV SD is turned off
Switch Page	Scrolls trough Layout Pages.
Skip Waypoint	If a task is defined it jumps to the next Waypoint.
Page Browser	Jumps from flight page directly into <i>Pages</i> menu (see Section 4.7).
Set Altimeter	Jumps to <i>Set Altimeter</i> menu option in order to allows user to set Altimeter
Task Navigator	Jumps from flight page directly into Task Navigator page (see Section 4.1).
Reset A2	Sets altimeter 2 to zero.
Airfields	Jumps from flight page directly into Near Airfields page (see Section 4.5).

4.8.15 Navigation Settings



Figure 4.36: Navigation Settings

In this menu, some of the navigation settings can be adjusted (Figure 4.36). A explanation of each option can be found on the following sections.

Safety Margin

The pilot can chose the safety margin they wish to use for any of the horizontal distances. Using a setting of 5m, (as shown in Figure 4.36) would mean that in the case of a waypoint cylinder, a pilot would be 5m deeper into the cylinder to ensure that it had been tagged and recorded. For airspace, they would trigger the buffer zone being 5m further away. The size of the safety margin can be changed by scrolling through the numbers using the UP and DOWN keys. Pressing ENTER moves to the next digit.

Turnpoint Size

The default turnpoint cylinder size is set in this menu. The size of the cylinder can be changed by scrolling through the numbers using the UP and DOWN keys. Pressing ENTER moves to the next digit. This value is used as the default cylinder size during task creation (see Section 4.1.1).

Datum

Two datum models can be set on the NAV SD . Options available are WGS 84 and FAI sphere. At the start of any competition, be sure to check what Datum is used by the scoring system to ensure that the correct distances are being reported.

4.8.16 Airspace settings

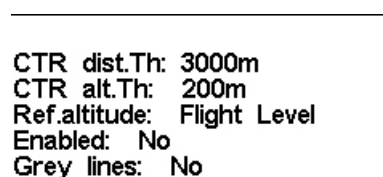

Figure 4.37: Airspace Settings

This menu allows the user to define certain parameters related with airspaces. Each of the parameters can be changed using UP, and DOWN, keys. Pressing the ENTER key confirms the value and jumps to next parameter. Changes can be undone by pressing the MENU key. As shown in Figure 4.37 there are 5 parameters related to the airspace which are explained in Table 4.11.

Table 4.11: Airspace Menu Settings

Function	Description
CTR dist. Th	Minimum horizontal distance that a pilot can be from an airspace without triggering an airspace warning. If this threshold is passed a warning is emitted (event).
CTR alt. Th	Minimum vertical distance that a pilot can be from an airspace without triggering an airspace warning. If this threshold is passed a warning is emitted (event).
Enable	If this parameter is set to YES, when a pilot is inside an airspace area (as shown in a 2D representation, but not necessarily inside the airspace), the airspace is drawn in Black. In this case all other airspaces are drawn in Grey.

In the example of Figure 4.38 it is represented an airspace (black), a distance threshold of 3000m and a vertical threshold of 200m (both in red).

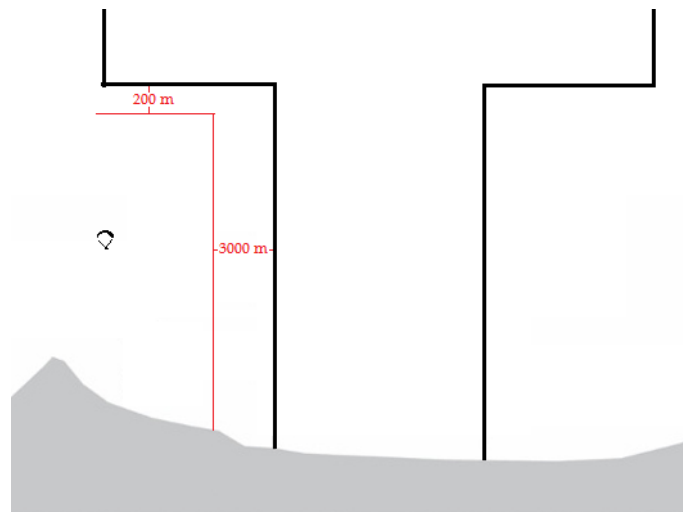

Figure 4.38: Airspace Settings Example

4.8.17 GPS status

In the main menu the NAV SD provides a detailed view of the *GPS* status, the current *position dilution of precision* (pdop) value, and the current *GPS* coordinates of the pilot.

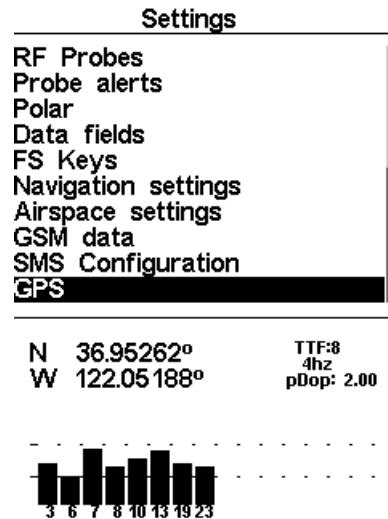

Figure 4.39: Satellite status

Figure 4.39 illustrates the *GPS* satellite reception page. In this example the NAV SD shows that 8 satellites are visible, and all 8 are being used to provide the position fix. Each bar shows the signal strength for each individual satellite. A filled bar indicates the NAV SD has a *lock* on that satellite. The *position dilution of precision* (pdop) shown gives an indication of how reliable the *GPS* data is at the moment. The lower the pdop value the more accurate the position fix. Values below 2.5 are fairly accurate. If the NAV SD is switched on in a location where no satellites are visible (indoors for example) it will go into wide search mode. If this occurs, going outdoors again will make the NAV SD take an increased amount of time to pick up satellite signals. If this occurs pushing ENTER on the *GPS* menu item will reveal the *Reset GPS* option, changing it to yes will make the NAV SD reset the *GPS* status and start a new search (see Figure 4.40). So if you notice NAV SD is taking abnormally long to get a fix (over 2 minutes) a *gps reset* will probably get it locked quicker.

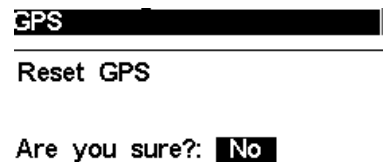

Figure 4.40: GPS Reset

5 TaskDefinition

In this section we will present an example of how to set a task in your NAV SD .

5.1 Setting up the task

Consider the task represented in Figure 4.5, and detailed in Table 5.1.

Table 5.1: Task example

Cylinder type	Time	Waypoint name	Map name	Cylinder size
LAUNCH	12:00:00 PM	LAUNCH	toff	
START	01:00:00 PM	WHALEB	TP1	2 km
CYLINDER		WHALEB	TP2	400 m
CYLINDER		SHEEP	TP3	3 km
CYLINDER		HEBRON	TP4	6 km
CYLINDER		GOOSEN	TP5	2 km
END OF SPEED SECTION		WHALEL	TP6	2 km
GOAL	05:00:00 PM	WHALEL	TP6	400m

In order to set up the task in your NAV SD you should go trough the following steps:

1. Delete any existing task on the NAV SD (see Section 4.1.2);
2. Add to the task, in the right order *LAUNCH*, *WHALEB* twice, *SHEEP*, *HEBRON*, *GOOSEN*, and finally *WHALEL* twice. The NAV SD will automatically assume *LAUNCH* as the takeoff since it is the first waypoint on the list. The first *WHALEB* will be used as Start, and the last *WHALEL* will be used to define the landing deadline. As waypoints are entered their properties can be edited as you enter each waypoint;
3. On the task list, select the first occurrence of *WHALEB* and edit it. Change the waypoint type to *Start Out*, set the distance to 2.000km, and the start time to 13:00. (Note that all times are in the 24 hour clock). Beware, that it is very important that the first occurrence of *WHALEB* be set as *Start*, otherwise the NAV SD will assume that *WHALEB* needs to be completed before the start gate, and that is not what is required for this task. Nothing needs to be changed for the second occurrence of *WHALEB* since the default values are the ones wanted.
4. Edit each of the waypoints *SHEEP*, *HEBRON*, and *GOOSEN* and set the distance to match the wanted one. All these waypoints are cylinders which is the default type.
5. Edit the first occurrence of *WHALEL* and change its type to *End of Speed Section*, the *Size* to 2.000km, and leave the *Time* with 00:00, and *Cone* with 0.0.
6. Edit the second occurrence of *WHALEL* and change its type to *GOAL*. The radius does not need to be changed since the radius is by default 400m. Continuously pressing the ENTER bottom will make the cursor jump to the next parameter which is the time. Time should be set to 17:00 which is the goal close time.

Upon completion of editing the task, the task list will show the distances for each leg, and the start gate will be shown with an *S*, end of speed section is shown with an *E* and the goal shown with a *G*. The completed task should look like Figure 5.1.

Waypoints (61)	Task	
ALTURA A	LAUNCH W	
AMBROS A	WHALEB	1.2 S
ANTELO A	WHALEB	0.0
ASHBUT A	SHEEP SHE	9.0
ASPEN AS	HEBRON M	21.8
BALL BAL	GOOSEN G	17.2
BEATTY B	WHALEL	18.9 E
BIKINI BIK	WHALEL	0.0 G
BLACK BL		
BLY BLY		
BONANZ B		
DC53		Total: 68.1

Type: Start out/enter
 Size: 002.000km
 Time: 13:00

Figure 5.1: Task example

Progressing through the above procedure sets the task on the instrument. Going back into the *Flight Mode Screen*, by pressing MENU bottom will automatically activate the task and start navigation.

Warning: After the route is edited navigation will be restarted at the beginning of the route.

Consider the same task represented in Figure 4.5, but now the *End of Speed Section* (ESS) is a cone with 4:1 ratio. In order to set up the task you should make the same steps defined in Section 5.1 except the step 5. As the cone as a ratio of 4:1 in this step you should set the *Cone* parameter to 4.0. The NAV SD provides some information to optimize the navigation when the ESS is conical. This information is provided through 5 additional data fields which can be included in a Layout page. Each of the data fields is explained in Section 3.2, but for a better understanding consider the situation of Figure 5.2.

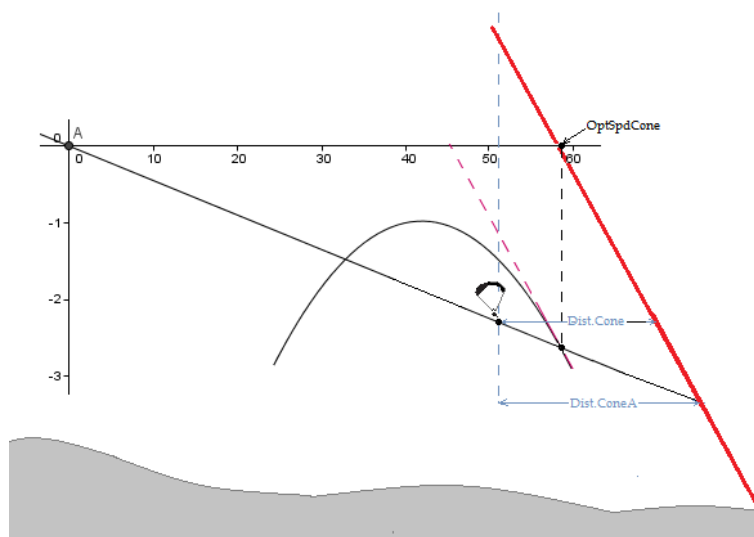

Figure 5.2: Conical End of Speed Section

In the example of Figure 5.2, the pilot is flying to the ESS at a certain true air speed (TAS). There is an optimum TAS value which minimizes the time to reach the ESS. This value depends on the polar and cone ratio, and is not affected by the wind or thermals. The NAV SD calculates the optimal TAS value

and show this in the *OptSpdCone* data field. In order to know the TAS the pilot needs a TASProbe. So for the pilots who do not have the TASProbe the NAV SD calculates the optimal ground speed by adding a Wind component to the TAS. The optimal ground speed is shown in the *OptGndSpdCone* Data Field.

Note: The *OptGndSpdCone* accuracy depends on the wind accuracy.

When the ESS is a cylinder the distance to the ESS does not depend on the pilot altitude. On the contrary, when the ESS is a cone the distance to the ESS depends on the altitude. Because of this, the NAV SD provide 2 distances in 2 different data fields. The *Dist.Cone* data field shows the distance to the ESS at the current pilot altitude (see Figure 5.2). As the glider glide ratio (GR) is usually positive and finite the altitude at which the pilot reaches the ESS is different from the current altitude, so real distance to the cone depends on the GR. The *Dist.ConeA* data field shows the horizontal distance to the ESS considering the expected average GR through the remaining path (see Figure 5.2).

Note: The expected GR is calculated considering historical data and also the wind component at that direction.

If a pilot is flying at the polar point corresponding to value indicated in the *OptSpdCone* data field it will take him a certain time to reach the cone. There is a vertical speed (thermal speed) which allows the pilot to climb and reach the cone in the same amount of time. This vertical speed value is shown in the *ConeVSpd* data field and corresponds to the minimum thermal speed which compensates climb instead of flying straight to reach the cone faster.

Note: The minimum thermal speed indicated in the *ConeVSpd* data field does not take in account the wind drift. If the winds blows in the cone direction the minimum thermal speed is lower than indicated, otherwise is higher.

6 McCreeady Functions

If the TASProbe is available then the NAV SD provides some data related with the McCreeady theory like the Speed to Fly, or McCreeady setting. The Speed to Fly is the TAS value which maximizes the average Cross Country speed considering a certain average thermal speed. This value is independent of the wind speed, because the fastest average speed achievable through the air corresponds to the fastest achievable average ground speed. To calculate the Speed to Fly the NAV SD takes in account the polar and the average thermal speed. The value is shown on the *SpeedToFly* data field.

Note: Traditional the average thermal speed used to calculate the Speed to Fly is manually set by the pilot (McCreeady Ring). On the NAV SD this value is calculated by averaging the last thermals climbed.

Conversely, for each TAS (Speed to Fly) value there is a average thermal speed which maximizes the Cross Country speed. This value is also calculated by the NAV SD and shown on the *McRdyNxtThrm* data field. Additionally, the *McRdyNxtThrm* value can also be visualized on the *Double Bar Analog Vario* (see Section 3.1.4). On the example of the Figure 6.1 Next thermal indicator points to 3.5m/s, while the Average Thermal shows something around 2.1m/s. Ideally, they should point the same value, so the pilot should reduce their speed. Naturally, he could maintain speed if he expects that the next thermal is stronger.

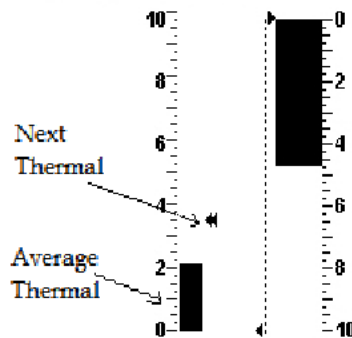

Figure 6.1: McCreeady Indicator

7 Firmware

Flymaster follows a policy of continuous improvement of its products. This means that a new version of firmware can be uploaded from our website periodically. The update process is simple.

Before beginning update procedure make sure you download the next files from the download page of NAV SD product section:

- Designer software (Windows, windows 7 64bits or MAC OS X)
- The last version of the firmware (xxxFirmware.fmf)

The first step of the updating procedure consists in installing the Designer software. In order to do that you should run the installation file and follow the on-screen instructions. The installation procedure includes the usb drivers, so there is no need to install further software.

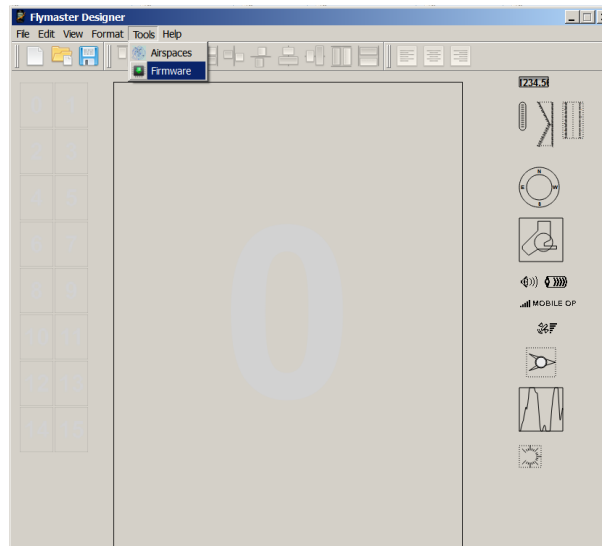

Figure 7.1: Firmware Menu Option

Once the Designer is correctly installed do the following procedure.

1. Open the Designer;
2. Select Tools->Firmware (see Figure 7.1);
3. Use the new box to choose the latest firmware file downloaded from our website;
4. Connect the NAV SD to the PC using the cable supplied. If it is the first time the NAV SD is connected to the PC, wait until Windows show the message that new hardware is present and ready to use.
5. Click the *Send to Instrument* button and the update should start automatic. A message appears saying *Programming...*, and a progress bar starts to grow. If after a few seconds nothing happens reset the NAV SD (see section Section 1.5).
6. When the process is finish the application shows a message saying *complete* (see Figure 7.2). Disconnect the USB cable and the NAV SD will start to work.

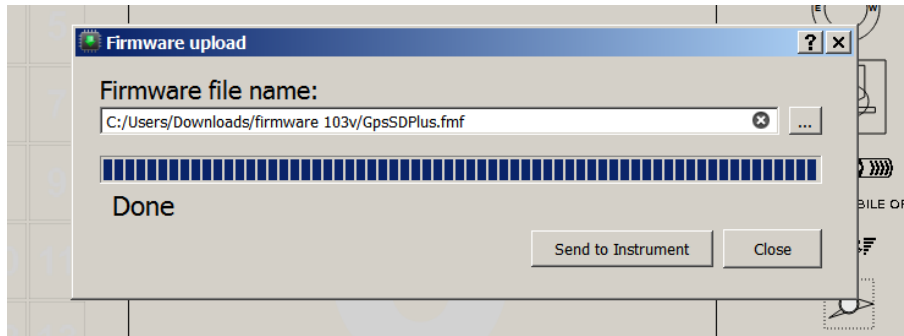

Figure 7.2: Firmware Update Done

8 Interfacing with GPSDump

With the Flymaster GPS it is possible to download tracks and upload waypoints using the GPSDump interface. GPSDump is freeware that can be downloaded to your MAC or PC. This section will describe how to use the GPSDump interface. It is assumed that the correct drivers have been installed on the computer and that GPSDump has been installed.

8.1 Configuring GPSDump

Before you can start interfacing your Flymaster GPS unit with your computer, you must first make sure that you have set the correct COM port on GPSDump. Connect your instrument to the computer and make sure both are switched on. In the GPSDump menu, select the drop down menu under MISC as shown in Figure 8.1 below.

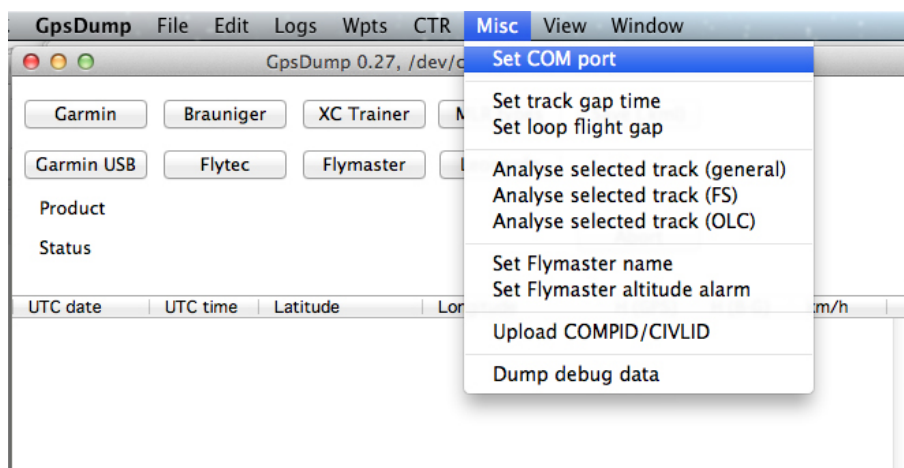

Figure 8.1: Setting up COM port

On a MAC when you select COM port you should get a screen like this: Figure 8.2

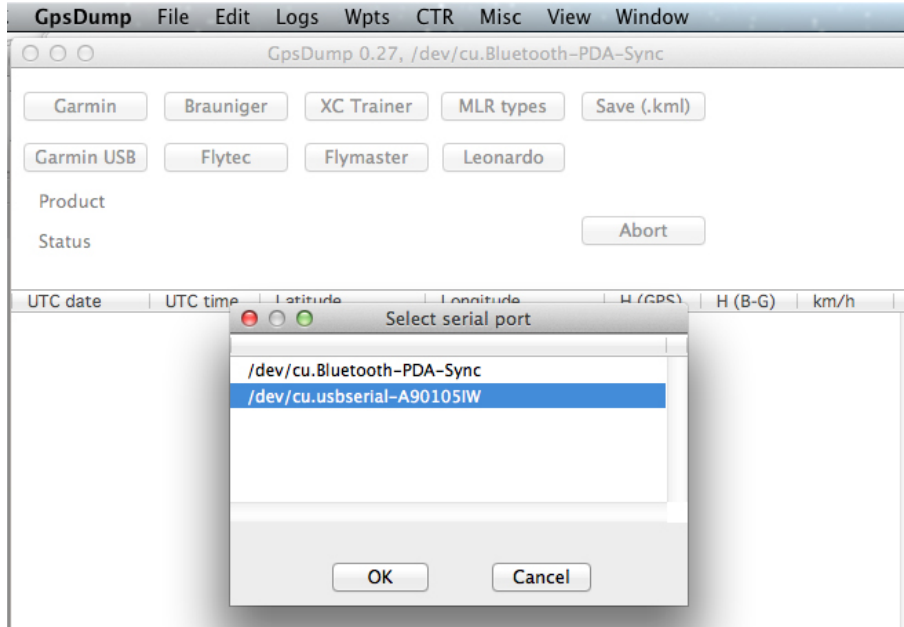

Figure 8.2: COM port options

Make sure you select the USBserial port as shown above.

On a PC when you select COM port a smaller dialogue box pops up listing all of the COM ports that are currently interfacing with the instrument. Flymaster instruments typically populate with high COM port numbers such as COM 11 in the example below Figure 8.3.

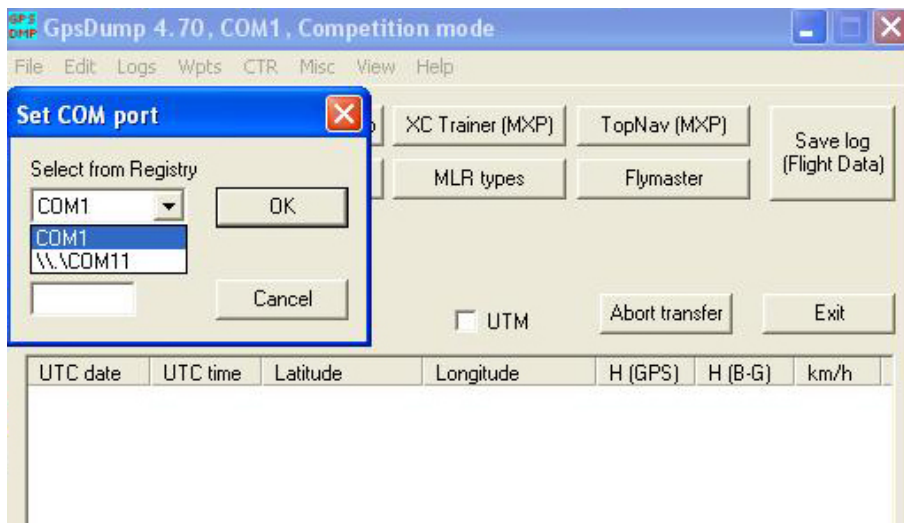
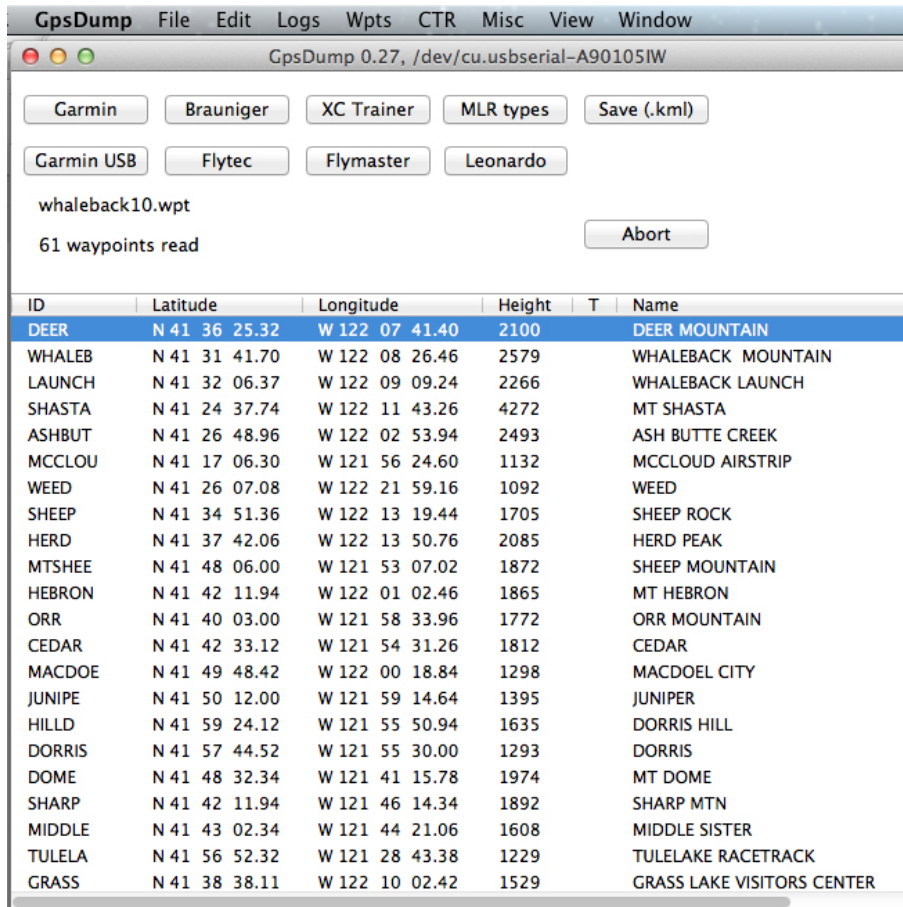

Figure 8.3: COM port options

Once the COM ports have been configured you should be good to go.

8.2 Uploading Waypoints

To upload waypoints, open the waypoint file in GPSDump. Your screen should like this Figure 8.4.



ID	Latitude	Longitude	Height	T	Name
DEER	N 41 36 25.32	W 122 07 41.40	2100		DEER MOUNTAIN
WHALEB	N 41 31 41.70	W 122 08 26.46	2579		WHALEBACK MOUNTAIN
LAUNCH	N 41 32 06.37	W 122 09 09.24	2266		WHALEBACK LAUNCH
SHASTA	N 41 24 37.74	W 122 11 43.26	4272		MT SHASTA
ASHBUT	N 41 26 48.96	W 122 02 53.94	2493		ASH BUTTE CREEK
MCCLOU	N 41 17 06.30	W 121 56 24.60	1132		MCCLOUD AIRSTRIP
WEED	N 41 26 07.08	W 122 21 59.16	1092		WEED
SHEEP	N 41 34 51.36	W 122 13 19.44	1705		SHEEP ROCK
HERD	N 41 37 42.06	W 122 13 50.76	2085		HERD PEAK
MTSHEE	N 41 48 06.00	W 121 53 07.02	1872		SHEEP MOUNTAIN
HEBRON	N 41 42 11.94	W 122 01 02.46	1865		MT HEBRON
ORR	N 41 40 03.00	W 121 58 33.96	1772		ORR MOUNTAIN
CEDAR	N 41 42 33.12	W 121 54 31.26	1812		CEDAR
MACDOE	N 41 49 48.42	W 122 00 18.84	1298		MACDOEL CITY
JUNIPE	N 41 50 12.00	W 121 59 14.64	1395		JUNIPER
HILLD	N 41 59 24.12	W 121 55 50.94	1635		DORRIS HILL
DORRIS	N 41 57 44.52	W 121 55 30.00	1293		DORRIS
DOME	N 41 48 32.34	W 121 41 15.78	1974		MT DOME
SHARP	N 41 42 11.94	W 121 46 14.34	1892		SHARP MTN
MIDDLE	N 41 43 02.34	W 121 44 21.06	1608		MIDDLE SISTER
TULELA	N 41 56 52.32	W 121 28 43.38	1229		TULELAKE RACETRACK
GRASS	N 41 38 38.11	W 122 10 02.42	1529		GRASS LAKE VISITORS CENTER

Figure 8.4: Waypoint list

Once the file has been opened, select all of the waypoints (COMMAND A in MAC and CONTROL A for PC).

In the drop down menu for WPTS you should see the following options (Figure 8.5).

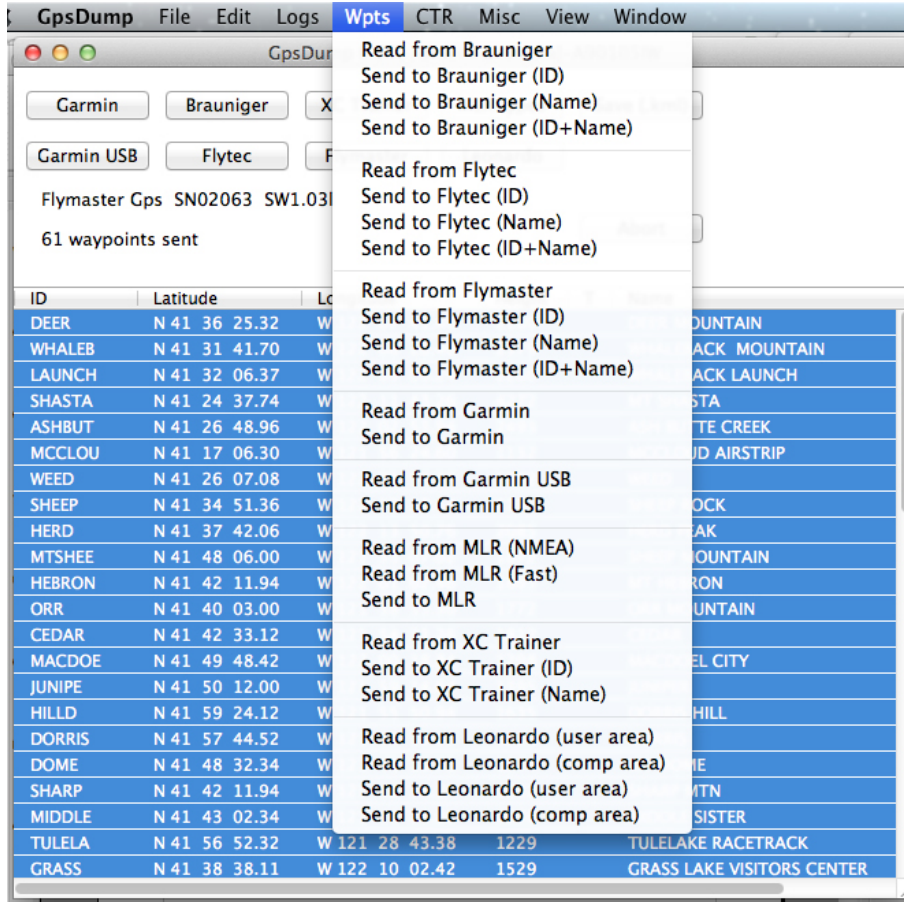

Figure 8.5: Waypoint options

Here you have the option of sending the waypoint ID, or the waypoint name or both. Once you select the type of waypoints to send you should see the the waypoints being sent to the instrument.

8.3 Downloading tracklogs

To download a track simply click on the FLYMASTER button on GpsDump.

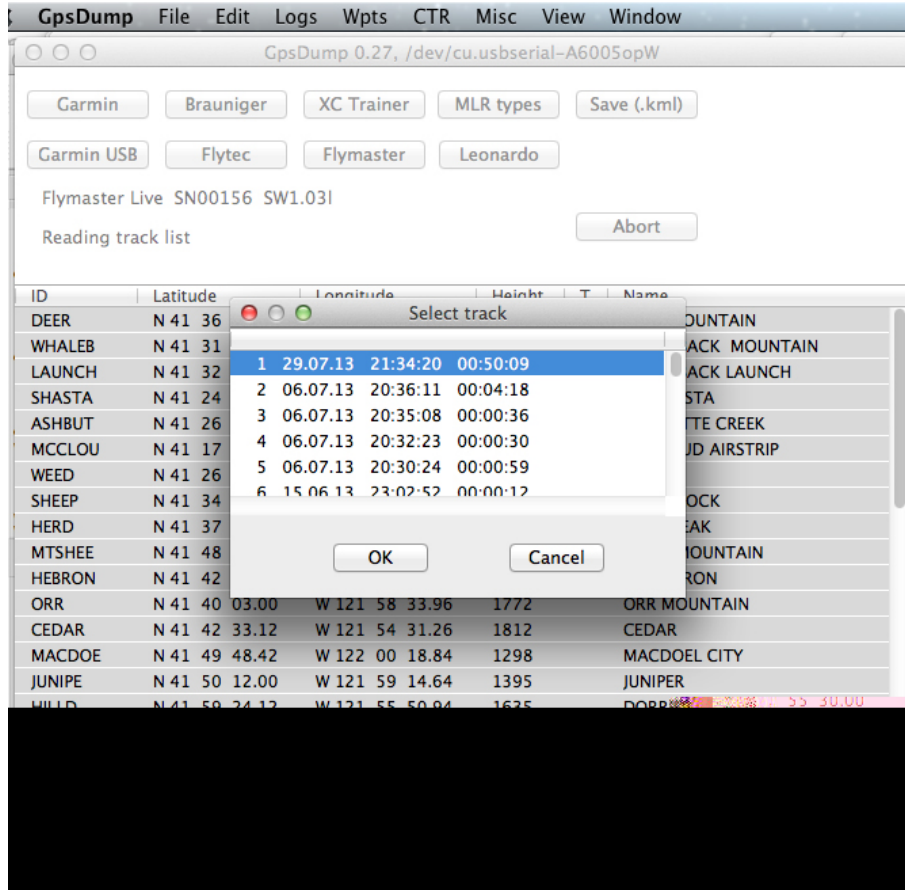

Figure 8.6: Downloading tracklog

When you click on the Flymaster button a list will populate showing all of the flight logs on the instrument (Figure 8.7).

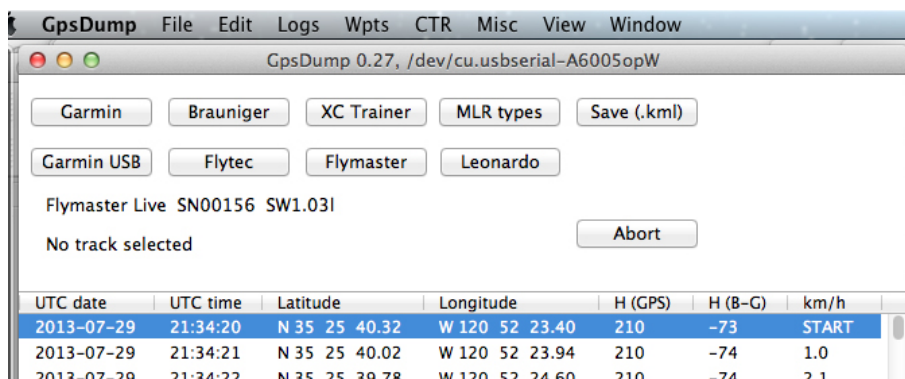

Figure 8.7: Tracklog list

Simply clicking on the desired flight will download the tracklog to the computer. Once the tracklog has been downloaded it is possible to save the tracklog in several different formats: IGC, KML, and GPX. KML is the recommended format if you wish to view on Google Earth.

Index

- Airspace Warning, [47](#)
- Alerts, [37](#)
- Base Frequency, [36](#)
- Climb Threshold, [36](#)
- Delete All Flights, [31](#)
- Delete Flight, [31](#)
- Flight Log, [30](#)
- Increments, [36](#)
- Memory capacity, [32](#)
- Sink Alarm, [36](#)
- Sink Threshold, [36](#)
- Sound
 - Alerts, [37](#)
 - Volume, [36](#)
- Time
 - Setting, [35](#)
- Volume, [36](#)
- Wind Arrow, [15](#)